



An Ergonomics Guide for Hospital Pharmacies





© 2004 Occupational Health and Safety Agency for Healthcare (OHSAH) in British Columbia. All rights reserved. OHSAH encourages the copying, reproduction, and distribution of sections of this document to promote musculoskeletal injury prevention in hospital pharmacies, provided that OHSAH is acknowledged. However, no part of this publication may be copied, reproduced, or distributed for profit or other commercial enterprise, nor may any part be incorporated into any other publication, without written permission of OHSAH.

2004 edition

National Library of Canada Cataloguing in Publication Data

Main entry under title:

An ergonomics guide for hospital pharmacies. — 2004 ed.—

Irregular.

ISSN 1710-0100 = An ergonomics guide for hospital pharmacies

1. Hospital pharmacies — Safety measures. 2. Hospital pharmacies — British Columbia — Safety measures. I. Occupational Health and Safety Agency for Healthcare in British Columbia.

RA975.5.P5E73 615.1'0289 C2003-960284-2



Acknowledgments

OHSAH is grateful to everyone who contributed to the development of *An Ergonomics Guide for Hospital Pharmacies* through focus-group meetings or through other input, feedback, and recommendations.

BC handbook review participants

- Amneet Aulakh Pharmacist, Vancouver General Hospital
 - Clemens Braun MSIP Advisor, Vancouver Coastal Health
 - Kathleen Cheng Pharmacist, Vancouver General Hospital
 - Maureen Haddock Ergonomist, Occupational Health and Safety, Richmond Health Services
 - Industry Services Department Prevention Division, Workers' Compensation Board of BC
 - Frances Kersteins Occupational Health and Safety Consultant, Health Employers Association of BC
 - Paul Koke Coordinator, Pharmacy Department, Children's and Women's Health Centre of British Columbia
 - Kenn Koo Supervisor, Department of Pharmacy, Vancouver General Hospital
 - Hanif Mithani Pharmacist, Vancouver General Hospital
 - Carmel Murphy Ergonomist, Healthcare Benefit Trust
 - Ana Rahmat Health and Safety Advisory Committee, Hospital Employees' Union
 - Dan Robinson Ergonomics Consultant, OHSAH
 - Andre Russo Ergonomist, Healthcare Benefit Trust
 - Diana Sinnige MSIP Program Advisor, Vancouver General Hospital
 - Russell Stead Occupational Therapist, Workplace Safety and Wellness, Royal Columbian Hospital
 - Lynne Taylor Administrative Secretary, Pharmacy Department, and HEU Occupational Health and Safety Steward, Children's and Women's Health Centre of British Columbia
 - Marianne Tofan Coordinator, Pharmacy Department, Children's and Women's Health Centre of British Columbia
 - Judy Village Ergonomist, Judy Village and Associates; UBC
 - Lidiya Vukasovic Pharmacy Technician, Vancouver General Hospital
- 



Special thanks

- Children's and Women's Health Centre of British Columbia, Vancouver
- Royal Columbian Hospital, New Westminster
- St. Paul's Hospital, Vancouver
- Vancouver General Hospital, Vancouver

OHSAH main contributors

- Elaine J. Lee Ergonomics Project Coordinator
- Justin LoChang Ergonomics Project Coordinator
- Chris Engst Ergonomics Program Manager
- Dr. Annalee Yassi Founding Executive Director





Who should read this guide

An Ergonomics Guide for Hospital Pharmacies is for anyone who needs practical information on how to make a hospital pharmacy a safer place to work. Employers will find information that will help them work through the ergonomics process, detecting potential musculoskeletal injury (MSI) risks and implementing effective control measures to prevent injury in hospital pharmacies. Workers will find specific health and safety information that will help them carry out their day-to-day tasks safely and efficiently.

Look for opportunities to manage the risk of MSI in your facility whenever you:

- design new pharmacies
- renovate old pharmacies
- purchase new equipment
- respond to pharmacy incidents
- develop and implement a proactive risk management program

Many of the recommendations in this guide have been developed and implemented successfully in collaboration with pharmacy workers throughout BC. You can photocopy and use material from the appendices (the checklists, tools, and templates) as working copies at your facility.



What's inside

This guide is divided into six parts:

Part 1: Introduction summarizes key points and defines a few terms.

Part 2: Musculoskeletal Injury (MSI) provides information on MSI, including common signs and symptoms, stages, risk factors, and how to determine if there is a risk of MSI in your pharmacy.

Part 3: General Pharmacy Controls describes controls for general risk factors associated with MSI, including force, repetition, awkward posture, static posture, and contact stress.

Part 4: Controls for Specific Pharmacy Tasks describes pharmacy-specific risk factors and controls. It includes sections on using dispensary computer workstations; using dispensary benches; prepacking tablets and capsules; making blister pack cards; replenishing ward stock; shipping, receiving, storing, and ordering; non-sterile manufacturing; using glove boxes; compounding; preparing chemotherapy bags; using syringes; and using carts.

Part 5: Education and Training describes typical components of an education module for pharmacy workers and guidelines for successful occupational health and safety training.

Part 6: Implementation and Evaluation provides information on implementing and evaluating an MSI prevention program in your pharmacy.

This guide also contains **Appendices**, including a signs and symptoms survey, a risk factor identification checklist, a summary of the WCB ergonomics requirements, an implementation guideline, a stretching routine, recommendations for selecting laminar flow hoods, and a reference list.



Throughout this guide you will also find “OSHTips,” occupational safety and health tips that will help make your workplace safer and more efficient.

The information in this guide is based on:

- ergonomics risk assessments done in hospital pharmacies throughout BC
- published material from other occupational health and safety agencies
- peer-reviewed scientific literature
- interviews with pharmacy workers
- the pilot project at Children’s and Women’s Health Centre of British Columbia



Contents

Who should read this guide v
 What's inside vi

Part 1: Introduction

Key points 2
 Terms 4

Part 2: Musculoskeletal injury (MSI)

Common signs and symptoms of MSI 8
 Stages of MSI 9
 Understanding MSI risk factors 11
 Is there a risk of MSI in your pharmacy? 13

Part 3: General pharmacy controls

Force 18
 Repetition 21
 Awkward posture 23
 Static posture 27
 Contact stress 29

Part 4: Controls for specific pharmacy tasks

Using dispensary computer workstations 32
 Using dispensary benches 35
 Prepacking tablets and capsules 37
 Making blister pack cards 38
 Replenishing ward stock 40
 Shipping, receiving, storing, and ordering 42
 Non-sterile manufacturing 44
 Using glove boxes 45
 Compounding 46



Preparing chemotherapy bags 49
 Using syringes 51
 Using carts 53

Part 5: Education and training

Sample education module for MSI prevention in hospital pharmacies 58
 Guidelines for occupational health and safety training 60

Part 6: Implementation and evaluation

Pre-implementation evaluation 62
 Implementation 64
 Post-implementation evaluation 65

Appendices

Appendix I: Signs and symptoms survey 68
 Appendix II: Risk factor identification checklist 70
 Appendix III: WCB ergonomics requirements 74
 Appendix IV: Implementation guideline 77
 Appendix V: Stretching routine 79
 Appendix VI: Recommendations for selecting laminar flow hoods .. 80
 Appendix VII: References 84





Introduction 1

This part includes the following sections:

- Key points
- Terms



Key points

Here is a summary of the key points that are covered in more detail throughout this guide:

- *Ergonomics* is designing jobs to fit workers to minimize or eliminate the risk of injury.
- Basic ergonomics risk factors include force, repetition, awkward posture, static posture, and contact stress.
- *Musculoskeletal injury (MSI)* includes injuries or disorders of the muscles, tendons, ligaments, joints, nerves, blood vessels, or related soft tissue, including sprains, strains, or inflammation that may be caused or aggravated by work.
- Common signs and symptoms of MSI include redness, swelling, pain, tenderness, tingling, weakness, and clumsiness.
- Risk factors may be present in a number of different tasks, including:
 - ~ entering and checking orders at dispensary computer workstations
 - ~ filling medication orders at dispensary benches
 - ~ prepacking tablets, capsules, and oral liquids
 - ~ picking and delivering ward stock
 - ~ accessing storage areas
 - ~ shipping and receiving medications
 - ~ making suspensions
 - ~ sterile compounding in laminar flow hoods
 - ~ carrying out syringe tasks
 - ~ lifting and handling objects
- It is important to identify high-risk tasks and the risk factors associated with all tasks.
- Identifying problems and solutions is only part of the process; implementing solutions is also important.



- Reduce as many of the risk factors within a task as possible.
- Solutions can be simple and inexpensive; they do not have to be elaborate or costly.
- Consider a solution's effects on other risk factors, other parts of the body, and other tasks performed in the department.
- Evaluation and worker consultation are important to ensure that implemented control measures work and have a positive impact on pharmacy workers.

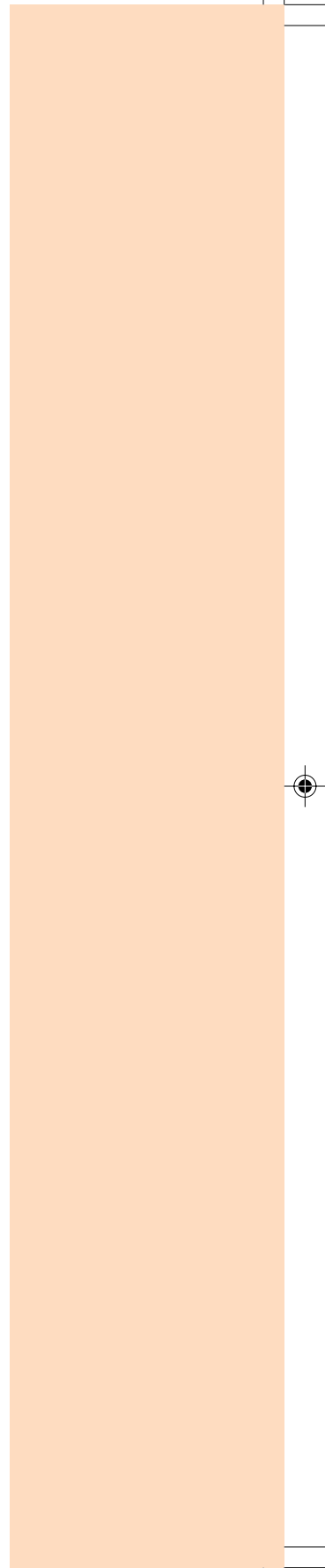



Terms

Ergonomics

Ergonomics is the science that plans and designs tasks to fit workers. Ergonomics deals with human characteristics, expectations, and behaviours in the design of the tasks people perform in their work and everyday lives. In part, ergonomics is aimed at decreasing the risk of injury to workers.

Ergonomics risk factors

Workstations, work areas, tools, machines, and appliances are often designed without considering the people who will be using them. This can lead to problems such as improper work surface heights, awkward working posture, and tools poorly designed for the intended task. Such problems are termed *ergonomics risk factors* because they can increase the risk of injury.

Musculoskeletal injury (MSI)

The WCB's Occupational Health and Safety Regulation defines *musculoskeletal injury (MSI)* as “an injury or disorder of the muscles, tendons, ligaments, joints, nerves, blood vessels or related soft tissue including a sprain, strain and inflammation, that may be caused or aggravated by work.” Work-related MSIs can make normal work routines uncomfortable and even painful. This can lead to stress or dissatisfaction at work, reduced productivity, the inability to perform some or all work duties, and even difficulty with activities at home.

The work of hospital pharmacists generally involves computer workstation tasks, including meticulous entering and verification of medication orders. Tasks performed by pharmacy technicians generally involve repetitive manipulation of objects using forceful, fine motor movements. Pharmacy technicians also carry, lift, push, and pull materials. Pharmacists and pharmacy technicians are at risk of acute and



chronic injuries. The fast-paced, demanding work environment of hospital pharmacies may contribute to the risk of injury.

Acute injuries

Acute injuries are injuries that occur immediately as a result of a single traumatic event. Examples of incidents that could cause acute injuries include:

- lifting a heavy box of supplies and straining your lower back
- slipping on a wet floor and twisting your ankle

Chronic injuries

Chronic injuries are injuries that occur over time as a result of repeated trauma or overuse of a body part. Symptoms develop in the affected part and the injury may lead to recurring discomfort if not treated properly. Examples of chronic injuries that may develop over time include:

- shoulder, elbow, or wrist tendinitis resulting from static or continual repetitive use in a laminar flow hood
- wrist pain resulting from repetitive typing at a computer workstation

The worst-case scenario is an injury that leaves the worker unable to perform his or her everyday duties and tasks, both at the workplace and elsewhere.

Risk control

A *risk control* is a solution put in place to eliminate or minimize the risk of MSI. Always try to eliminate the hazard wherever practicable.

Implementation of risk control measures may include:

1. elimination or substitution (for example, automating a task)
2. engineering controls (for example, using lifting devices or pumps)
3. administrative controls (for example, using job rotation or improved work techniques)
4. personal protective equipment (for example, wearing knee pads), where engineering or administrative controls are not practicable

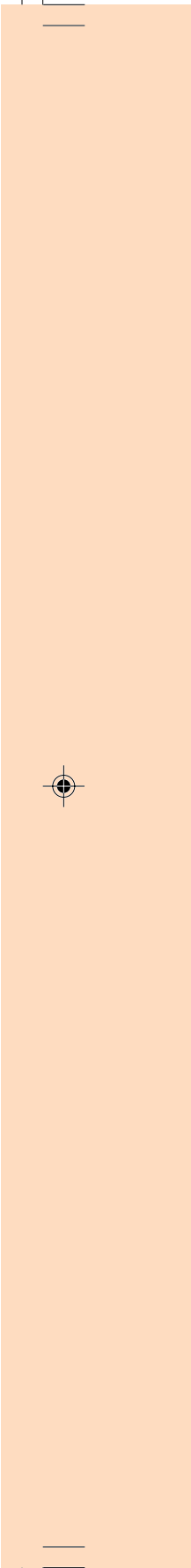



Musculoskeletal injury (MSI)

2

This part provides information on musculoskeletal injury (MSI). It includes the following sections:

- Common signs and symptoms of MSI
- Stages of MSI
- Understanding MSI risk factors
- Is there a risk of MSI in your pharmacy?

Common signs and symptoms of MSI

Knowing the common signs and symptoms of MSI can help prevent injuries. *Signs* are things you can see, such as swelling or redness. *Symptoms* are things you can feel but cannot see, such as numbness, tingling, or pain.

Table 2.1 Typical signs of MSI

Sign	Observation
Redness	Does the skin look red?
Swelling	Does the area look swollen?
Loss of normal joint movement	Do you have less range of motion than you normally would?

Table 2.2 Typical symptoms of MSI

Symptom	Observation
Pain (sharp, shooting, or dull)	Do you feel pain in the injured body part when you try to use it or even while at rest?
Tenderness	Is the area painful or sensitive to touch?
Heat or burning	Does the injured area feel warmer than normal? Do you feel a burning sensation?
Tingling, pins and needles, or numbness	Do you feel a tingling sensation along the injured area? Are you losing feeling at or around the injured area?
Heaviness	Does the body part feel as if it weighs more than normal?
Clumsiness or weakness	Are you dropping items frequently? Do you find it difficult to grasp or hold onto objects? Is it hard to hold onto things that are normally easy for you?
Cramping or spasm	Does the muscle stay in a contracted state or contract and relax on its own?



Stages of MSI

Recognizing the signs and symptoms of a developing MSI and responding to them are key steps in preventing further injury. Signs and symptoms of MSI tend to follow the stages described in Table 2.3.

Table 2.3 Stages of MSI

Early stage

- Discomfort such as aching or fatigue may be present during work but lessens or disappears with rest (for example, during breaks, overnight, or on weekends).
- No effects on work performance are usually noticed.
- This stage may last for weeks or months.



Middle stage

- Pain, aching, and fatigue may be present at work and at home.
- Visible signs of MSI may also be present.
- Signs and symptoms may not disappear with rest.
- Performance of activities may be somewhat affected.
- This stage may last for several months.



Late stage

- Pain, aching, and fatigue may be present all the time, even when the affected body part is rested.
- Performance of activities and sleep are significantly affected. Even light duties at work are very difficult.
- This stage may last for months or years.

OSHTip:

Early detection and reporting of an MSI is crucial.



Injuries in the early or middle stages have a better chance of healing properly if adequate rest is taken or tasks are modified to reduce stress on the affected body part. In the late stage, injuries may not heal completely but effects can be minimized if dealt with properly.

Some MSIs can progress from early to late stages within a week. If you feel early signs and symptoms of MSI, report your injury to your supervisor immediately and fill out an injury or incident report form. See Appendix I for a signs and symptoms survey.

By reporting signs and symptoms, you can help improve health and safety in your workplace. Reporting signs and symptoms helps:

- address your signs and symptoms at an early stage, preventing further injury
- identify risk factors related to the environment, equipment, workers, work organization, and procedures
- determine recommendations for appropriate work modifications that will reduce the risk of MSI





Understanding MSI risk factors

Understanding risk factors and identifying where they might occur can help prevent MSI. When assessing the degree of risk, it is important to ask three basic questions:

1. What is the intensity or magnitude of the risk factor (how much)?
2. What is the frequency of exposure to the risk factor (how often)?
3. What is the duration of exposure to the risk factor (how long)?

If a task presents high levels of any one risk factor or presents multiple risk factors, the level of risk increases greatly. This section describes the following risk factors:

- force
- repetition
- awkward posture
- static posture
- contact stress

Part 3 describes general controls for each of these risk factors.

Force

Physical effort that places a high load on the muscles, tendons, ligaments, and joints increases the body's energy demands and the possibility of injury. For example, carrying a tray of full intravenous (IV) bags may cause forceful exertion, especially if the tray is heavy. Even light loads may increase the risk of injury if held for a long duration. Whenever possible, ask for help when lifting heavy objects. Manual manipulation such as pushing a solution through a syringe filter may also cause forceful exertion involving the hands, wrists, and fingers.



Repetition

A repetitive task is a task that uses the same muscle groups repeatedly. Muscles and tendons do not have enough time to rest, which may lead to fatigue as well as tissue damage and irritation. For example, filling syringes can be a repetitive task.

Awkward posture

Awkward posture occurs when the body part has to work in a position that is not “natural.” For example, when a pharmacy technician crushes pills on a countertop that is above waist height, it puts the shoulders in an awkward posture. This requires more force from the muscles than if the technician were crushing pills on a lower countertop.

Static posture

Static posture is a body position held without motion for a prolonged period. General guidelines suggest that a posture held for more than 20 seconds is static. Muscles tire quickly in static postures because blood flow is restricted. For example, a pharmacist leaning over a counter to check an order may put the lower back in a static bent position.

Contact stress

Contact stress occurs when body parts come into contact with hard or sharp objects. Contact stress can result in injury to nerves and tissues beneath the skin. For example, leaning on a work surface can cause contact stress on the elbows; kneeling on a floor to reach a low shelf can cause contact stress on the knees.



Is there a risk of MSI in your pharmacy?

Employers should follow this seven-step ergonomics process to eliminate or minimize risks of MSI in pharmacies.

Step 1. Consultation

During each step of your MSI prevention program, consult with your:

- workers to identify problems
- joint health and safety committee (or worker health and safety representative)
- Health and Safety Department (for example, an occupational health and safety advisor or ergonomist)

Step 2. Education

Educate workers about identifying work-related risk factors, recognizing early signs and symptoms of MSI, and knowing their potential health effects.

Step 3. Risk identification

Identify the tasks that pose a risk of MSI and identify the risk factors associated with those tasks. See Appendix II for a risk factor identification checklist.

Step 4. Risk assessment

Assess identified risk factors to determine the degree of risk to workers. Consult with affected workers and a representative sample of other workers who perform similar tasks.



Step 5. Risk control

Implement control measures to eliminate or minimize the risk factors.

Implementation may include:

- elimination or substitution (for example, automating a task)
- engineering controls (for example, using lifting devices or pumps)
- administrative controls (for example, using job rotation or improved work techniques)
- personal protective equipment (for example, wearing knee pads), where engineering or administrative controls are not practicable

Step 6. Training

Train workers to use the control measures to make their jobs safer.

Step 7. Evaluation

Evaluate control measures and the entire program at least once a year to determine their effectiveness at minimizing the risk of MSI. Also conduct evaluations whenever workloads or processes change significantly and whenever an injury or other incident occurs.



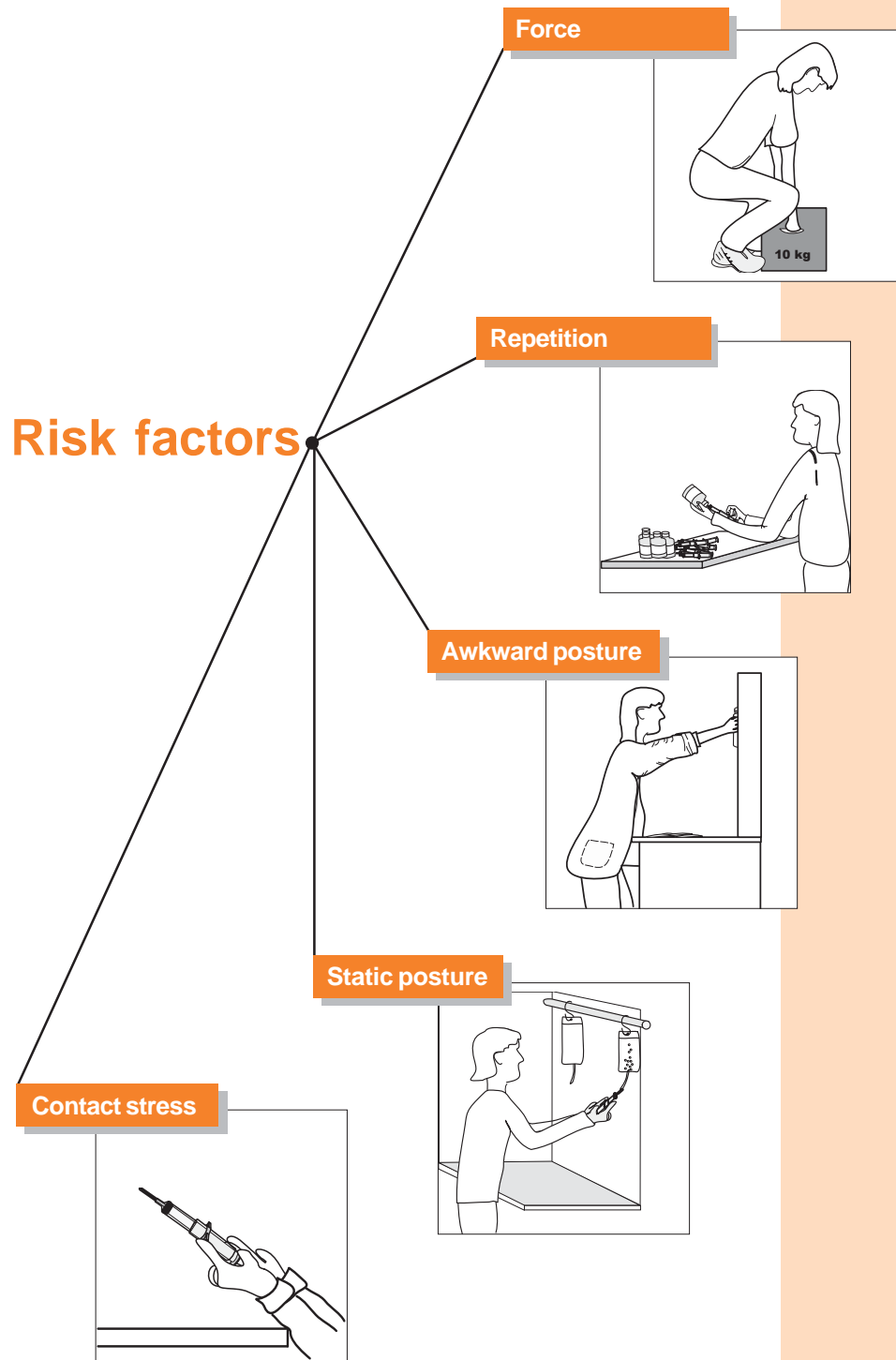

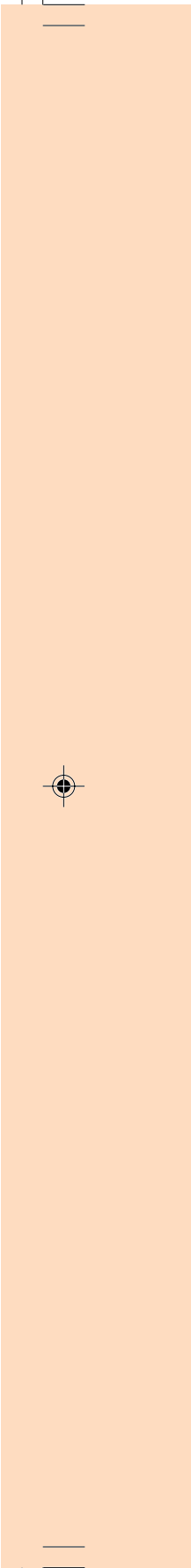



General pharmacy controls

3

This part provides information on MSI control measures for your pharmacy. It includes the following sections:

- Force
- Repetition
- Awkward posture
- Static posture
- Contact stress



Force

Good body mechanics can help lessen the muscular force necessary to carry out tasks, which will reduce the risk of MSI.

Lifting, lowering, and carrying loads

Workers and employers should consider the following recommendations for lifting, lowering, and carrying loads:

- Plan your route before lifting and carrying the load.
- Before lifting, test the load to determine if it is light enough to lift. Employers should ensure that heavy loads are labelled to indicate to workers the weight of the load.
- Instead of carrying one heavy load, separate it into smaller, lighter packages and make multiple trips, use a cart or trolley, or ask a co-worker for help.
- Use a cart so you can push the load rather than carry it. Employers should ensure that casters and wheels receive regular maintenance so they will move easily on the floor.
- Avoid reaching below mid-thigh height and above shoulder height. Place or store heavy items at mid-body height.
- Handle heavy or unbalanced loads from a standing position rather than a sitting position.
- Make sure you can fit through narrow spaces that you may encounter.
- Make sure that your fingers are out of the way when you set down the load.



Workers should consider the following techniques for lifting, lowering, and carrying loads:

- Stand with the load positioned between your legs.
- Keep your arms and the load as close to your body as possible.
- Bend with your knees and let your legs and hips do most of the work.
- Do not round or slump your back.
- Tighten your stomach and trunk muscles but do not hold your breath. Breathe out as you lift.
- Keep your feet shoulder width apart.
- Point your toes in the direction you are facing to avoid twisting your back.
- Do not use fast or jerky motions when lifting, especially when lifting heavy objects.

Pushing and pulling

Employers should ensure that handles are between waist and shoulder height. Workers should consider the following recommendations for pushing and pulling:

- Push whenever possible. Pushing is generally safer than pulling.
- Always use two hands when pushing or pulling. Do not pull with one arm extended behind your body.
- If your vision is blocked when pushing a load from behind, push it from the front corner. Avoid pulling the load.
- Keep your upper arms close to your body with your elbows in. Keep your hands at or slightly above waist level. Keep your feet shoulder width apart.
- Bend your knees slightly and move the load by shifting your weight. For example, when pushing place one leg in front of the other, bend your knees, and move the load by shifting your weight from your back leg to your front leg.
- Take small steps when turning corners to avoid twisting your back.



Power grips vs. pinch grips

A power grip involves the entire hand. A pinch grip uses the fingertips only. A power grip is preferable because it takes less muscular effort than a pinch grip to provide the same amount of force.

Gripping

Workers should consider the following recommendations for gripping or grasping objects:

- Use tools and other hand implements that are designed to be operated with the whole hand, not just with one finger and thumb.
- If you need gloves, make sure they fit well. They should not be loose or bunch up and should offer some surface friction to improve grip, if necessary.
- Use power grips rather than pinch grips whenever possible. Grasp objects with your whole hand, not just your fingertips.

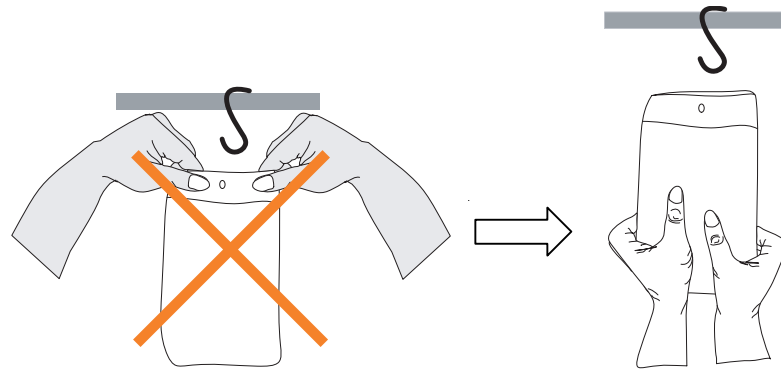

Pinch grip

Power grip



Repetition

Prevention methods include job rotation, minimizing repetitive motions, stretching, rest breaks, and micro-pauses.

Job rotation

In pharmacies the same body parts and postures are used for many tasks. Rotating workers through different tasks or duties may help vary postures, reduce exposure to stressful tasks, and reduce exposure to risk factors (as well as prevent boredom). Employers and workers should consider the following job rotation recommendations:

- Vary tasks such as packing pills, preparing medications, and working in sterile rooms throughout the day.
- Alternate between sitting, standing, and sitting-standing positions (using sit-stand stools) where it is safe to do so.

Minimizing repetitive motions

Minimizing prolonged performance of highly repetitive motions will help reduce the risk of MSI. Employers should consider providing mechanical or automated devices (for example, pill crushers, bottle openers, or Cornwall syringes) to assist workers with highly repetitive tasks.

Workers should consider the following recommendations:

- Alternate working positions to avoid overusing any single muscle or group of muscles.
- Try to combine or eliminate tasks.
- Alternate hands to perform tasks.
- Pace yourself when performing repetitive tasks.



OSHTip:
Frequent, shorter rest breaks are better than infrequent, longer breaks.

Stretching

Stretching circulates blood through the muscles, relieves muscle tension, develops flexibility, and increases body awareness. Workers should stretch on a regular basis throughout the day (especially if they are maintaining a static posture), not just when they feel muscle tension or discomfort. For a stretching routine, look for the OHSAAH *Stretch It Out!* poster, which may be displayed in your pharmacy, or see Appendix V for a reproduction of this poster.

Stretching is only one component of injury prevention. General fitness, including aerobic exercise and muscle strengthening, is also important. Before beginning a stretching or fitness routine, consult with your doctor, especially if you have an existing injury or condition.

Workers should consider the following stretching recommendations:

- To make stretching easier, warm up first by slowly swinging your arms and moving your legs for about 20–30 seconds.
- Stretch for a few minutes before starting work to prepare your muscles for the task at hand.
- Hold each stretch for 20–30 seconds without bouncing.
- Stretch muscles that are being used for a particular job or task.
- Stretch only as far as is comfortable.
- If you feel pain, stop the stretch. If the pain persists, consult with your facility's first aid attendant or your doctor.

Rest breaks and micro-pauses

Workers should take rest or pause breaks to prevent fatigue and to give their muscles a chance to recover. Take frequent micro-pauses of 10–15 seconds. During micro-pauses, change your posture and stretch briefly. A micro-pause stretch is shorter in duration than a normal stretch but is still beneficial. It is also important to take rest or pause breaks when you feel fatigued or your muscles are sore.



Awkward posture

Good body mechanics can help minimize awkward posture, which will reduce the risk of MSI. Workers should consider the following recommendations to minimize awkward posture:

- Move your body closer to the object or move the object closer to you.
- Bend your knees and use your legs rather than bending from the waist.
- Store items between knee and shoulder height whenever possible. Store frequently used items at approximately waist height.
- Face the object you are working with. Point your toes in the direction you are facing to avoid twisting your back. For example, if an object is behind you, do not twist and reach behind your body to grab or move the object. Instead, shift your feet to face the object.
- Keep your elbows as close to your body as possible.
- If the work area is too high, lower the work area, sit (if there is enough legroom), or stand on a platform, footstool, or ladder (as long as it is safe to do so and does not create a tripping or falling hazard). For more information, see “Footstools,” on page 27.
- Support your lower back when sitting and avoid prolonged sitting.
- Sit on a stool or chair rather than squatting, kneeling, or bending over while you work.
- Use tools and other hand implements that are designed to keep your wrists straight rather than bent.

Shelf heights, work surface heights, and workspace organization can all affect worker posture.

Shelf heights

Shelf heights should not be higher than the shoulder height of the shortest worker. Employers should provide stepstools for shelves that are higher than shoulder height. If a table or counter is between the workers and the shelf, lower the height of the shelf to prevent awkward or excessive reaching.



OSHTip:

The more precise a task is, the higher the work surface should be. The heavier a task is, the lower the work surface should be.

Work surface heights

Work surfaces that are too low lead to awkward back and neck postures. Work surfaces that are too high lead to awkward shoulder posture.

Employers should ensure that working heights are adjustable to suit each individual. If this is impracticable and there is a wide range in the height of your workers, provide two or more workstations of different heights to allow for height variations.

For shorter workers who stand in one spot, consider using a platform to raise them to the appropriate height. Ensure that the platform is stable, wide, and long enough that there is no risk of the workers falling or tripping.

For taller workers who stand in one spot, consider placing a raised surface on the counter to raise the working height (see the illustration on page 36).

Consider each task individually to help determine the appropriate work surface height for that task. Ask the following questions:

- What type of work is being performed?
- How much visibility does the task require?
- Is reading required?
- What are the required reaching distances?
- How much force does the task require?

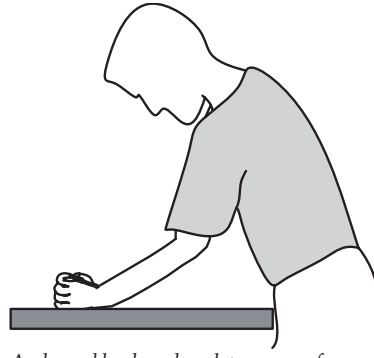

Awkward back and neck postures often result when the work surface is too low.



Awkward shoulder posture often results when the work surface is too high.



Working heights for specific kinds of tasks

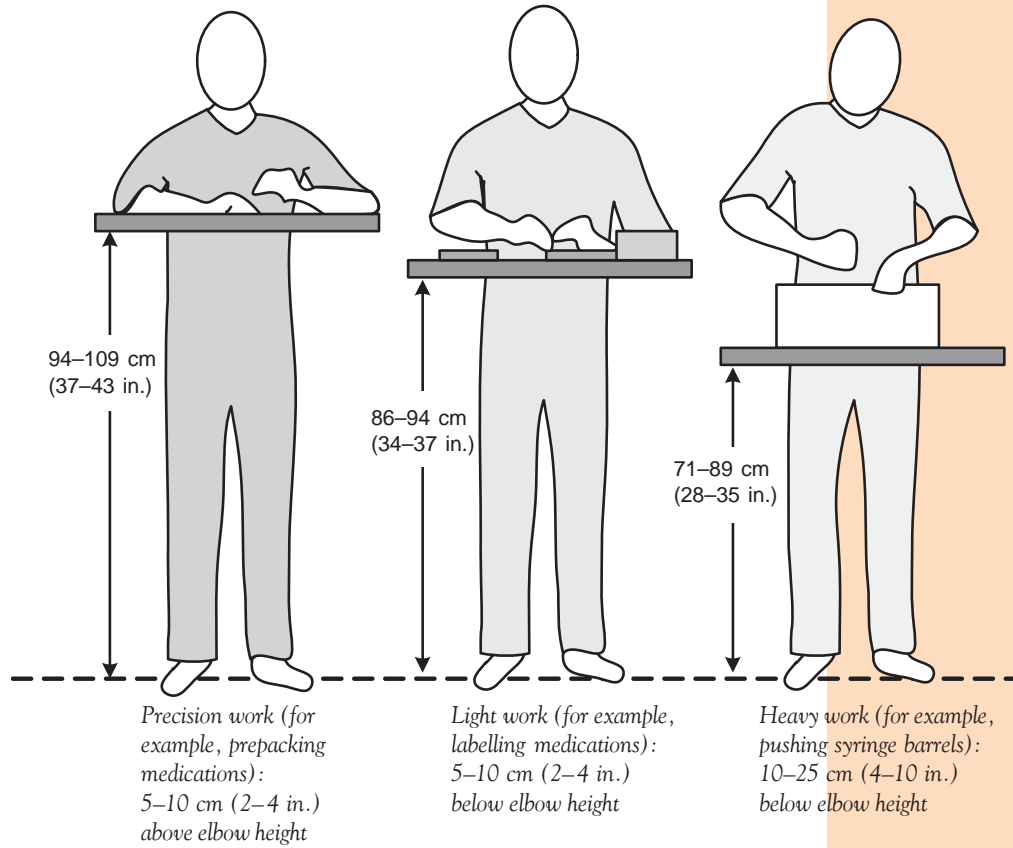

What is elbow height?

Elbow height is the distance between the ground and your elbow when you are standing with your arms relaxed by your sides.

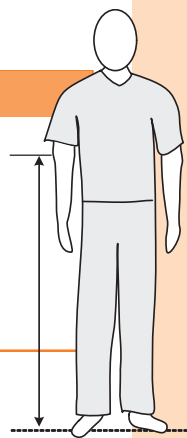

Workspace organization

The organization of the workspace around a worker will influence the worker's posture and consequently the worker's risk for injury. Poorly organized workspaces may result in awkward reaching and bending, increasing the risk of injury to the neck, shoulders, and lower back.

Place frequently used and heavier items in the most accessible locations, 33–43 cm (13–17 in.) from workers. Place infrequently used and lighter items 53–63 cm (21–25 in.) from workers. Place rarely used items away from the main work area.

Recommended reaching distances for workers

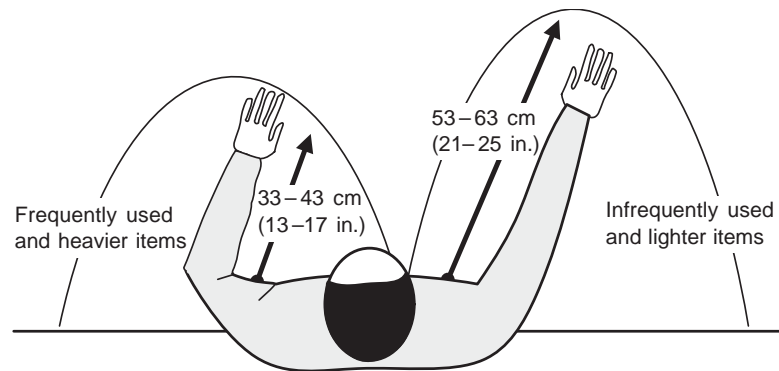

Place frequently used and heavier items on shelves between knee and shoulder height, as close as possible to waist height. Place lighter items on the lowest and highest shelves.

Whenever possible, move obstacles out of the way to minimize awkward posture and reduce the risk of tripping or collisions. Carts, boxes, or trash should not obstruct aisles or block exits.



Static posture

Reducing the stress associated with static posture can help reduce the risk of MSI. Prevention methods described in this section include anti-fatigue matting, footstools, sit-stand stools, and footwear. Other prevention methods for static posture include job rotation, stretching, rest breaks, and micro-pauses. For more information, see “Repetition,” on pages 21–22.

Anti-fatigue matting

Anti-fatigue matting provides a softer surface to stand on, reducing the fatigue associated with standing for long periods. Employers should place anti-fatigue matting in areas such as beside dispensary benches or in prepacking areas. Matting should always be kept dry and clean to maintain its cushioning properties.

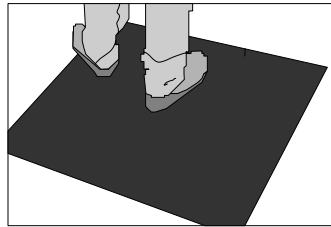

Anti-fatigue matting helps reduce fatigue associated with standing for long periods.

When purchasing anti-fatigue matting, consider where it will be used. If the matting requires frequent cleaning, consider using smaller sections of matting with interlocking pieces to allow for ease of transport. Purchase anti-fatigue matting with bevelled edges to allow carts to roll over the edges easily and to minimize tripping hazards.

Footstools

Footstools or footrails allow workers to raise one foot up, which helps shift body weight and reduce stress on the lower back and legs when standing for long periods. From time to time, workers should switch the foot they have on the stool or rail. Store footstools out of the way when they are not in use so they do not create a tripping hazard.

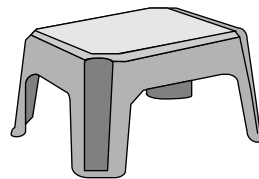

Footstools can help reduce stress on the lower back and legs.

OSHTip:

Adjust workstations so workers have enough space to change their working positions periodically.

OSHTip:

For more information on footwear, see OHSAH's brochure *What Makes Good Footwear for Work?*

Sit-stand stools

Employers should consider providing sit-stand stools so workers can alternate easily between sitting and standing positions. Sit-stand stools are most appropriate when the worker does not have to move around much, is not handling anything heavy, and does not have to reach far. If suitable, use sit-stand stools to reduce stress on the lower back and the legs of workers who stand for long periods.



Footwear

Footwear should provide enough cushioning to relieve stress on the back and legs. Footwear should fit properly and have non-slip soles.

Tips for buying footwear

Consider these guidelines when buying footwear:

- Buy footwear late in the afternoon when your feet are swollen and at their maximum size.
- Bring along an old pair of work shoes to compare.
- If you wear orthotics, bring them along and try on the shoes with the orthotics inserted.
- If your feet are different sizes, buy shoes to fit the larger foot.
- Shoes should fit snugly without being too tight. There should be about 1.5 cm (½ in.) of room between your big toe and the end of the shoe.

Wear and tear

The frequency with which footwear needs to be replaced depends on how fast wear and tear occurs. The slip resistance of the outsoles may start to decline after the shoes are worn for the first time. Over time, the outsoles will deteriorate and the midsoles will break down and lose their cushioning capabilities.



Contact stress

Employers should consider the following recommendations to minimize contact stress:

- Add padding to sharp or hard edges (for example, on cart handles, scissors handles, and countertop edges) to reduce contact stress on hands and arms.
- Bevel or round the edges of tables, ledges, and shelves.

Workers should avoid leaning against edges (for example, against countertops or laminar flow hoods).

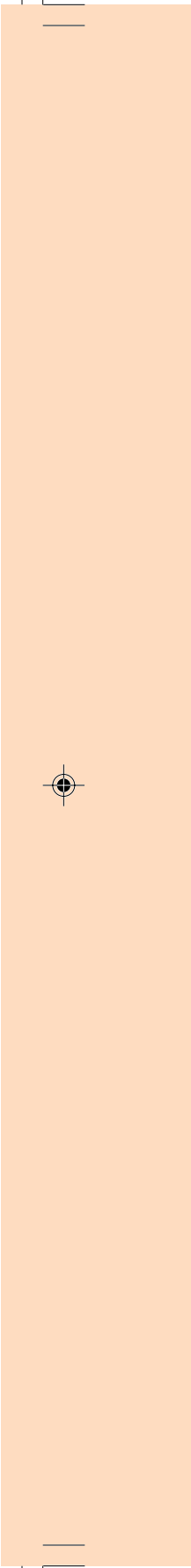



Controls for specific pharmacy tasks **4**

This part is divided into sections that deal with specific pharmacy tasks. Each section describes potential risk factors that you may encounter and potential controls for eliminating or minimizing those risk factors. Implement the controls that best fit your facility's needs. See Appendix II for a risk factor identification checklist that will help you determine which areas of your pharmacy may pose a risk of MSI. This part includes the following sections:

- Using dispensary computer workstations
- Using dispensary benches
- Prepacking tablets and capsules
- Making blister pack cards
- Replenishing ward stock
- Shipping, receiving, storing, and ordering
- Non-sterile manufacturing
- Using glove boxes
- Compounding
- Preparing chemotherapy bags
- Using syringes
- Using carts



Using dispensary computer workstations

Pharmacists use dispensary computer workstations to process medication orders. A patient's medication order may arrive at the pharmacy as a hard copy, electronic copy, or telephone request. A pharmacist enters the information into the computer system and checks it for appropriateness in therapeutic terms and in terms of dose, frequency, and duration. The pharmacist then generates a label with the name of the patient and the medication.

A pharmacy technician prepares and packages the medication (see "Using dispensary benches," on page 35), then a pharmacist checks it for accuracy of preparation before it is delivered to the patient ward. Entering and checking medication orders may occur at the same workstation or at different workstations.

Potential risk factors

- Keying for long durations at computer workstations may cause awkward postures and repetitive motions of the hands and wrists.
- Reading and writing orders on workstation surfaces may cause static neck and shoulder postures.
- Checking orders at poorly arranged computer workstations may cause awkward neck, shoulder, back, arm, wrist, and hand postures when keying, writing, and reading.
- Working with poor lighting may contribute to eye strain.



Potential controls

When setting up dispensary computer workstations, employers should consider the following:

- logical process flow of medication orders, beginning with the request for the medication order and ending with delivery of the medication to the ward
- frequency and type of communication between pharmacy technicians and pharmacists (for example, speaking or passing order forms or orders)
- number of different workers using the workstation
- variety of tasks performed at the workstation

Employers should also consider implementing the following controls, where applicable:

- Ensure that pharmacists alternate between computer work and other work throughout the day to decrease repetition.
- Train pharmacists to use computer shortcut keys to decrease their use of the mouse.
- If pharmacists are responsible for monitoring the door, arrange the workstation so that the door is in direct view and workers do not need to twist their heads. Alternatively, use a buzzer system for visitors.
- Ensure that there is adequate space at the workstation to place all frequently used items (for example, unchecked medications or order sheets) within arm's reach.
- Ensure that workers who need telephones have one within arm's reach. Consider using hands-free headsets if telephones are used regularly.
Note: Consider the frequency with which workers leave the workstation and the usual duration of calls before providing telephone headsets.
- Ensure that the workstation has adequate lighting.



Provide adjustable equipment

Employers should ensure that workstations have adjustable equipment (for example, task chairs with armrests, footstools, document holders, keyboard trays, and mouse palm pads). Follow these guidelines:

- Make a variety of devices available to workers and allow them to choose equipment that fits them the best to minimize the risk of MSI.
- Provide document holders or supports that have adjustable angles and are sturdy enough to write on. A padded writing lip can reduce the risk of MSI.
- Ensure that there is space between keyboard trays and workers' thighs so there is no contact between the two.

Adjust your workstation to fit you

Workers should adjust workstations to fit them:

- Adjust the chair first so your feet are flat on the floor (or the footrest) without pressure on the back of your legs.
- Adjust the keyboard so it is slightly below elbow height. If the keyboard is at a fixed height, raise the chair to the appropriate level and support your feet as necessary.
- Make sure the “tilt” supports underneath the keyboard near the back are down or closed and the keyboard is pulled close to your body.
- Move the mouse so it is beside the keyboard and at the same level.
- Adjust the monitor so it is in line with the keyboard, about an arm's length away. The top line of text on the monitor should be at eye level.
- Use a document holder for data entry forms.
- Keep the phone within the area for items used occasionally, 53–63 cm (21–25 in.) away from you. If you are right-handed, keep the phone on the left. If you are left-handed, keep it on the right.
- Arrange the workstation and monitor to reduce glare on the screen.



Using dispensary benches

Workers use dispensary benches to prepare and label non-sterile medication.

Potential risk factors

- Reaching for and preparing medications may cause awkward neck and shoulder postures.
- Preparing medications may cause repetitive arm, hand, and wrist motions.
- Uncapping and capping medication bottles may cause repetitive, forceful finger motions.
- Standing for long periods on hard surfaces may fatigue the back and legs.
- Filling unit-dose syringes may present risks (see the potential risk factors in “Using syringes,” on page 51).

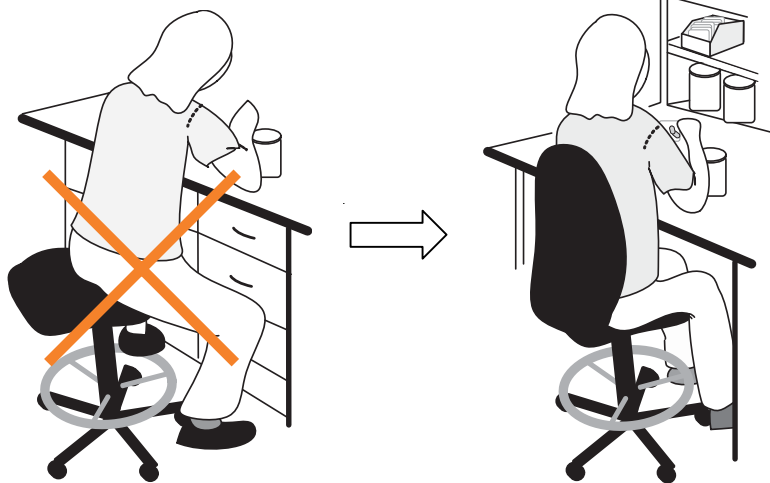

The drawers under this dispensary bench make it difficult for the worker to get close to the work while seated and may result in awkward posture.

Remove the drawers so the worker can assume a more neutral back posture. Move supplies that were stored under the bench to the top of the bench or another location.

Potential controls

Employers should consider implementing the following controls, where applicable:

- Attach pullout shelves near the ends of dispensary benches so workers can temporarily increase work surfaces and minimize reaching distances.
- Provide a variety of working heights to accommodate tasks that require precision and power (see “Work surface heights,” on pages 24–25). Increase working heights by adding raised countertops that can be used as needed.

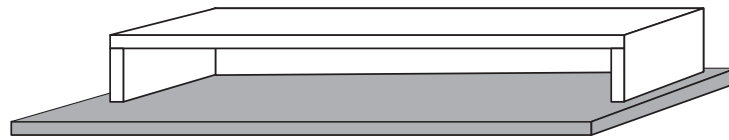

Add raised countertops to increase work surface heights.

- Provide stepstools so workers can access higher shelves without excessive reaching.
- Provide bottle openers so workers can avoid pinch grips and use less force to open medication bottles. Bottle openers can be hand tools or units attached to work surfaces.
- Provide anti-fatigue matting for standing workers.
- Provide height-adjustable chairs or stools so workers can vary their posture.
- For reducing syringe risk factors, see the potential controls in “Using syringes,” on page 52.

When arranging stock, store heavier and frequently used items on shelves between hip and shoulder height.



Prepacking tablets and capsules

Various pill packing machines and systems are available for prepacking tablets and capsules; they generally involve heat sealing a single dose in a package.

Potential risk factors

- Looking down at pills may cause static neck posture.
- Placing pills in trays may cause repetitive finger motions.
- Uncapping and capping medication bottles may cause repetitive, forceful finger motions.
- Standing for long periods on hard surfaces may fatigue the back and legs.

Potential controls

Employers should consider implementing the following controls, where applicable:

- Set work surface heights for light to precision tasks (see “Work surface heights,” on page 25).
- Provide automated unit-dose packaging machines to reduce repetitive finger motions.
- Provide bottle openers so workers can avoid pinch grips and use less force to open medication bottles. Bottle openers can be hand tools or units attached to work surfaces.
- Order supplies in larger volumes to reduce opening of containers.
- Provide anti-fatigue matting for standing workers.
- Provide height-adjustable chairs or stools so workers can vary their posture.

Workers should pour pills onto tray areas and use their hands or tools to sweep pills into tray slots rather than sorting them individually.

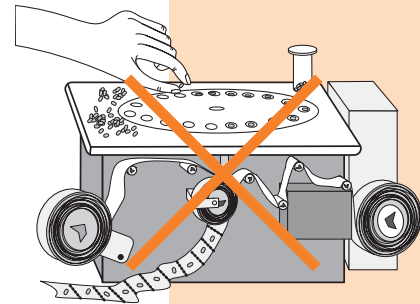

Avoid sorting pills individually using your fingers.

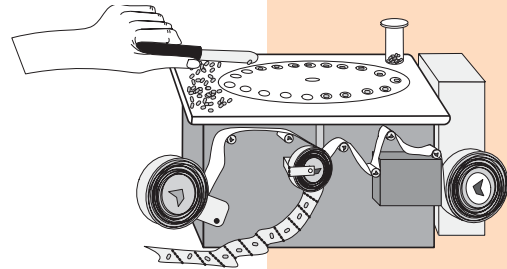

Using your hand or a tool to sweep pills into tray slots will reduce repetitive finger motions.



Making blister pack cards

Unit-dose strips and blister packs are commonly used for medication distribution and control. A blister pack consists of a cardboard backing with a clear plastic cover for protecting and displaying medication.

Potential risk factors

- Looking down at pills and blister pack cards may cause static neck posture.
- Closing the lids of manual heat sealers may cause awkward and forceful shoulder, elbow, and wrist motions.
- Trying to see under heat sealer lids may cause awkward neck and back postures.
- Placing pills in trays may cause repetitive finger motions.
- Uncapping and capping medication bottles may cause repetitive, forceful finger motions.
- Standing for long periods on hard surfaces may fatigue the back and legs.

Potential controls

Employers should consider implementing the following controls, where applicable:

- Set work surface heights for light to precision tasks (see “Work surface heights,” on page 25).
- Provide a heat sealer that does not require the lid to be closed or one that has a lid handle at the front.

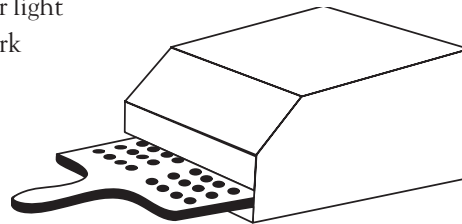

Using heat sealers without lid handles helps prevent awkward and forceful shoulder, elbow, and wrist motions.



- Alternatively, add an extension to the heat sealer's handle to minimize reach distances and increase the length of the lever arm.
- Determine the optimal time for heat sealing and post this time — together with a timer or a clock that has a second-hand — near the heat sealer so workers do not have to visually check the blister pack card for completion.
- Provide bottle openers so workers can avoid pinch grips and use less force to open medication bottles. Bottle openers can be hand tools or units attached to work surfaces.
- Provide anti-fatigue matting for standing workers.
- Provide height-adjustable chairs or stools so workers can vary their posture.

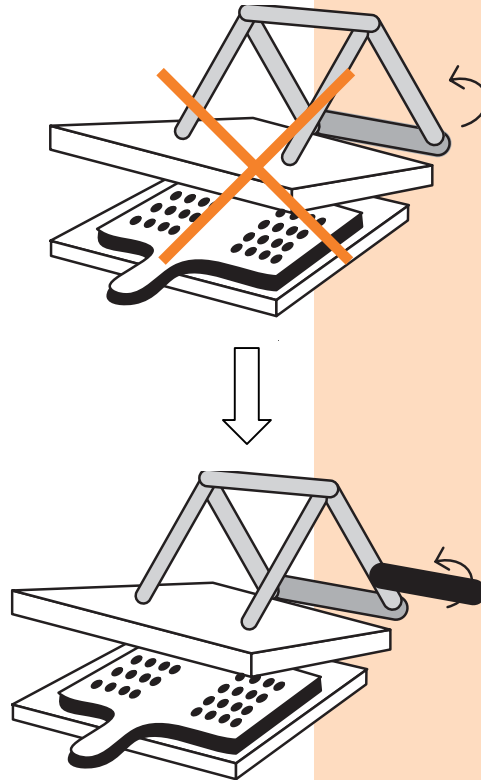

Adding an extension to the heat sealer's handle will minimize reach distances.

Replenishing ward stock

Ward stock refers to medications and supplies that are stocked in ward patient care areas but are not individually labelled for specific patients. Workers replenish ward stock by comparing items on the ward with a list of items required. Workers then pick items from pharmacy storage shelves, assemble them by ward, and deliver them.

Training for pharmacy workers should include the location and layout of medications and supplies in the storage area as well as safe lifting techniques, policies, and procedures.

Potential risk factors

- Reaching for items stored on high shelves may cause awkward shoulder posture.
- Bending down for items stored on low shelves may cause awkward back and shoulder postures.
- Organizing ward stock items may cause awkward back, neck, and shoulder postures.
- Lifting boxes of supplies may cause forceful exertion.
- Standing for long periods on hard surfaces may fatigue the back and legs.
- Pushing and pulling carts may present risks (see the potential risk factors in “Using carts,” on page 53).



Potential controls — pharmacies

Employers should consider implementing the following controls, where applicable:

- Provide stepstools so workers can access higher shelves without excessive reaching.
- Provide work surfaces such as counters or low carts where workers can place collected medications and supplies.
- Provide anti-fatigue matting for standing workers.
- Provide height-adjustable chairs or stools so workers can vary their posture.
- For reducing cart risk factors, see the potential controls in “Using carts,” on pages 53–56.

Workers should repack items purchased in large bulk containers in smaller containers to make handling easier.

Potential controls — nursing units

Employers should consider providing stepstools so workers can access higher shelves without excessive reaching. When arranging stock, store heavier and frequently used items on shelves located between hip and shoulder height.

OSHTip:

During delivery, bring to each ward only the items that are needed. Generate a comprehensive list of required stock items for each individual ward. Gather and pre-sort these items in the pharmacy before delivering them to the ward.



Shipping, receiving, storing, and ordering

The shipping and receiving area of a pharmacy is generally a large area near an exterior door or a hallway leading to an exterior door. Vendors deliver supplies on pallets or in large bulk containers and workers move the supplies to storage shelves. Expired or obsolete medications may also be stored in the shipping and receiving area before shipping. Controlled substances such as narcotics are stored in a vault or locked room. Workers use a work table for paperwork and ordering new supplies.

Training for pharmacy workers should include the location and layout of medications and supplies in the storage area as well as safe lifting techniques, policies, and procedures.

Potential risk factors

- Reaching for items stored on high shelves may cause awkward shoulder posture.
- Bending down for items stored on low shelves or pallets may cause awkward back and shoulder postures.
- Organizing ward stock items may cause awkward back, neck, and shoulder postures.
- Lifting boxes of supplies may cause forceful exertion.
- Standing for long periods on hard surfaces may fatigue the back and legs.
- Pushing and pulling carts may present risks (see the potential risk factors in “Using carts,” on page 53).

Potential controls

Employers should consider implementing the following controls, where applicable:

- Reorganize shelves to limit reaching to high shelves or bending to low shelves. If possible, set bottom shelves 15–20 cm (6–8 in.) above



ground level and top shelves at shoulder height, approximately 120 cm (48 in.) above ground level.

- Provide stepstools so workers can access higher shelves without excessive reaching.
- Provide anti-fatigue matting for standing workers.
- Provide height-adjustable chairs or stools so workers can vary their posture.
- For reducing cart risk factors, see the potential controls for employers in “Using carts,” on pages 53–55.

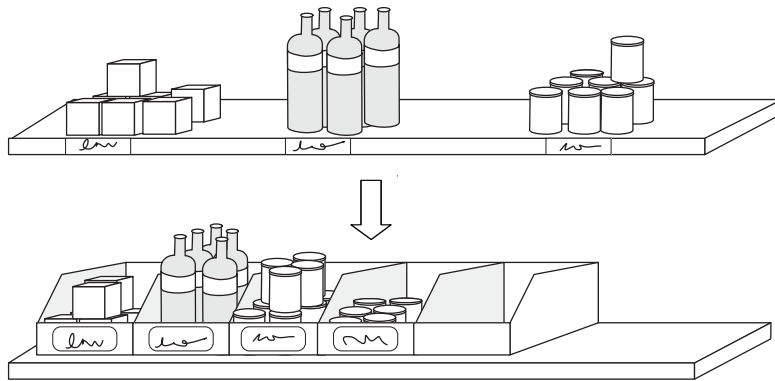

Organize supplies on shelves in storage units with dividers to help keep items separate and minimize stock picking errors. This will also optimize the use of shelf space and minimize the possibility of items falling off.

Workers should consider using the following controls:

- Keep areas in front of shelves clear of obstructions so you can assume proper posture when lifting.
- Bring supply pallets as close as possible to storage areas to minimize handling.
- Store heavier and frequently used items on middle shelves and light and less frequently used items on higher shelves.
- Use carts or dollies to transport boxes or bins that do not have wheels.
- For reducing cart risk factors, see the potential controls for workers in “Using carts,” on pages 55–56.

Non-sterile manufacturing

Non-sterile manufacturing includes making suspensions, ointments, and creams. When making suspensions, workers typically crush tablets or open capsules and crush the contents. Ointments and creams frequently incorporate powders such as hydrocortisone. It is also common to mix two different ointments or creams together.

Potential risk factors

- Pressing down with spatulas may cause repetitive and awkward motions of the shoulder, elbow, hand, and wrist, as well as forceful exertions of the shoulder, arm, hand, and wrist.
- Manually crushing pills (for example, using a mortar and pestle) may cause repetitive and awkward motions of the shoulder, elbow, hand, and wrist, as well as forceful exertions of the shoulder, arm, hand, and wrist.

Potential controls

Employers should consider implementing the following controls, where applicable:

- Purchase pre-made ointments whenever possible.
- Provide an automated pill crusher to crush pills.
- Provide an electric mixer to combine powders with creams whenever possible.
- If workers have to make suspensions manually, ensure that they use work surface heights suitable for exertion of downward force. See “Work surface heights,” on pages 24–25.

Workers should levigate ointments on top of a heat pad or preheat ointment bases in a microwave or hot water bath to make it easier to dissolve the powder. Ensure that the heat will not alter the properties of the ointment.



Using a lower work surface helps minimize awkward posture and force when performing tasks such as making ointment.



Using glove boxes

A glove box is a sealed chamber that incorporates two arm-length gloves so workers can handle objects inside the box. Workers use glove boxes for tasks that require a contained environment — for example, mixing and preparing noxious medications. Glove boxes allow workers to handle potentially toxic materials without exposing the workers or the workplace to the materials.

Potential risk factors

- Manipulating objects in glove boxes, particularly for long periods during a shift, may cause awkward back, shoulder, and arm postures and repetitive reaching to the side.
- Manipulating objects in glove boxes may cause repetitive finger motions.
- Standing for long periods on hard surfaces may fatigue the back and legs.
- Inadequate lighting, surface glare, or an unclean glove box exterior may cause awkward neck and back postures as workers lean closer to the task.

Potential controls

Employers should consider implementing the following controls, where applicable:

- Provide height-adjustable chairs or stools so workers can vary their posture.
- Provide anti-fatigue matting for standing workers.
- Provide adequate lighting for glove box tasks.
- Ensure that the exterior surface of the glove box is kept clean.

Workers should use power grips to handle objects in the glove box and try to move all materials from the side chamber to the main chamber of the glove box at the same time to reduce the amount of side reaching.

Compounding

Compounding is the preparation, mixing, assembling, packaging, and labelling of a customized medication in a sterile environment.

Potential risk factors

- Hanging IV bags on overhead bar hooks in laminar flow hoods may cause awkward back and shoulder postures.
- Manipulating IV bags hanging from the overhead bar may cause neck extension, particularly for shorter workers.
- Using pinch grips to handle IV bags and medication bottles increases exposure to force.
- Sealing IV bag tubes and opening packages may cause awkward wrist and elbow postures and require excessive force.
- Looking down at work surfaces in laminar flow hoods may cause awkward, static postures of the neck, torso, legs, arms, and wrists.
- Twisting to see paper order sheets or other written instructions outside laminar flow hoods may cause awkward back and neck postures.
- Pressing forearms and wrists on the edges of laminar flow hoods may cause contact stress.
- Shaking vials to dissolve powders while reconstituting may cause repetitive wrist motions.
- Poor lighting may contribute to eye strain.
- Standing for long periods on hard surfaces may fatigue the back and legs.
- Filling syringes may present risks (see the potential risk factors in “Using syringes,” on page 51).

Sterile manufacturing

Sterile manufacturing includes compounding tasks and the preparation of chemotherapy bags (see pages 49–50). Pharmacy technicians use vertical and horizontal laminar flow hoods to prepare sterile products such as intravenous (IV) medications or total parenteral nutrition (TPN) in a particulate-free environment. Pumps such as the Baxter Micromix and Automix machines are used to reduce the number of syringe tasks.



Potential controls

Employers should consider implementing the following controls, where applicable:

- Provide an IV pump or a syringe pump infusion system to reduce the risk of MSI and decrease the amount of time pharmacy technicians spend compounding.
- Provide an apparatus to support IV bags on the surface of the laminar flow hood rather than on the IV bar.

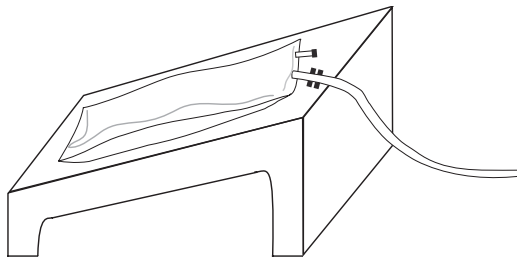

Using an IV bag support helps minimize awkward postures associated with hanging IV bags.

- Lower the height of the overhead bar in the laminar flow hood or provide two bars of different heights.
- Use hooks of different lengths to lower IV bags on the overhead bar to the appropriate working height for each worker.
- Provide a height-adjustable table for the laminar flow hood.
- Provide a crimping tool that allows neutral wrist posture and requires minimal force to seal IV bag tubes.
- Provide spring-loaded scissors to ease package opening.
- Provide a laminar flow hood with clear sides so workers can post frequently needed information on the outside facing in, allowing them to read it from their position on the opposite side of the hood.
- Provide a laminar flow hood with decreased work surface depth and a bigger opening so workers can comfortably sit or stand while performing tasks. See Appendix VI for specific recommendations for selecting laminar flow hoods.
- Install closed-cell foam padding on the sharp front edge of the hood or provide elbow rests to decrease contact stress.



- Provide a vial shaker for workers to dissolve powders during the reconstitution process.
- Ensure that lighting is adequate for precision tasks.
- Provide anti-fatigue matting for standing workers.
- Provide height-adjustable chairs or stools so workers can vary their posture.
- For reducing syringe risk factors, see the potential controls in “Using syringes,” on page 52.

Workers should consider using the following controls:

- Stand when hanging IV bags.
- Use power grips to handle IV bags and hold them close to the base when hanging them. See page 20 for an illustration of a power grip.



Avoid hanging IV bags on hooks on high overhead bars in laminar flow hoods.



Preparing chemotherapy bags

Workers usually prepare bags of parenteral chemotherapy in sterile environments such as biological safety cabinets or fume hoods. Such cabinets generally have a sash window (a glass screen) that covers the top three-quarters of the cabinet opening, through which workers view their work. Sash windows restrict workers' arm motions and may lead to workers using static and awkward postures to perform their duties. In addition, the bottoms of biological safety cabinets are often closed in and do not allow for legroom.

Potential risk factors

- Reaching for and manipulating materials may cause awkward back and shoulder postures.
- Inadequate legroom reduces workers' ability to get close to the work while seated and may cause awkward posture.
- Using pinch grips to handle IV bags and medication bottles increases exposure to force.
- Sealing IV bag tubes and opening packages may cause awkward wrist and elbow postures and require excessive force.
- Looking down at work surfaces in biological safety cabinets may cause awkward, static postures of the neck, torso, legs, arms, and wrists.
- Twisting to see paper order sheets or other written instructions outside biological safety cabinets may cause awkward back and neck postures.
- Pressing forearms and wrists on the edges of biological safety cabinets may cause contact stress.
- Poor lighting may contribute to eye strain.
- Filling syringes may present risks (see the potential risk factors in "Using syringes," on page 51).



Many biological safety cabinets have a sash window that restricts arm motions.



Potential controls

Employers should consider implementing the following controls, where applicable:

- Provide a turntable for storing equipment in the cabinet to minimize reaching.
- Ensure that there is adequate legroom under the biological safety cabinet.
- Provide a height-adjustable biological safety cabinet so workers can adjust the height of the work surface.
- Install closed-cell foam padding on the sharp front edge of the cabinet or provide elbow rests to decrease contact stress.
- Use non-glare glass for the sash window.
- Keep the sash window clean and ensure that vision into the window is unobstructed.
- Ensure that lighting is adequate for precision tasks.
- Limit the continuous time and consecutive days that workers spend performing tasks in the biological safety cabinet and alternate these tasks with other duties.
- For reducing syringe risk factors, see the potential controls in “Using syringes,” on page 52.

Workers should consider using the following controls:

- Place all materials within reaching distance (see “Workspace organization,” on page 26).
- Use power grips to handle IV bags and hold them close to the base when hanging them. See page 20 for an illustration of a power grip.

Follow regulations and guidelines

Employers should regularly review regulations and guidelines for using laminar flow hoods and biological safety cabinets (for example, the Canadian Society of Hospital Pharmacists’ *Guidelines for Preparation of Sterile Products in Pharmacies*).

Note: Although ergonomics recommendations suggest that workers keep materials close to the edge of the laminar flow hood or biological safety cabinet, workers should work at least 15 cm (6 in.) into the hood or cabinet to contain airflow and to protect themselves and the materials they are working with.



Using syringes

Pharmacy workers use syringes frequently in both sterile and non-sterile areas. The most common syringe tasks are withdrawing medications from vials and adding them to IV bags. Occasionally, workers draw medication up into syringes and set them aside to add later.

The amount of wrist force required to perform syringe tasks is influenced by the type and viscosity of the medications, sizes of the syringe barrels, and use of additional equipment such as filters. The difficulty of a syringe task may increase if the worker must hold the vial or IV bag with one hand and manipulate the syringe with the other.

Potential risk factors

- Drawing up and adding medications may cause repetitive, forceful pinch grips. These are usually one-handed tasks that may cause forceful exertion as a result of working with:
 - ~ gloves or gloves covered with alcohol
 - ~ viscous medications
 - ~ large-volume syringes
 - ~ small-bore needles
- Depressing syringe plungers may cause contact stress on the palms of the hands.
- Preparing medications may cause repetitive arm and wrist motions as well as awkward neck and shoulder postures.
- Holding inverted vials or medication bottles may cause static wrist posture and awkward hand posture.

OSHTip:

Contact different syringe manufacturers for samples of their products. Some manufacturers make syringes that require less force to draw up and depress than others do. Discuss with your purchasing department the advantages of switching to syringes that require less force.

Potential controls

Employers should consider implementing the following controls, where applicable:

- Provide a mechanism to hold vials and medication bottles. This will allow workers to use both hands to manipulate syringes. Ensure that the holder can accommodate a range of vial and medication bottle sizes.
- Provide an automated syringe drawing device for repeated filling of syringes (for example, Cornwall syringes that provide a mechanical advantage). Ensure that workers use such devices correctly.
- Minimize the use of large syringes to reduce the force associated with drawing up medications.

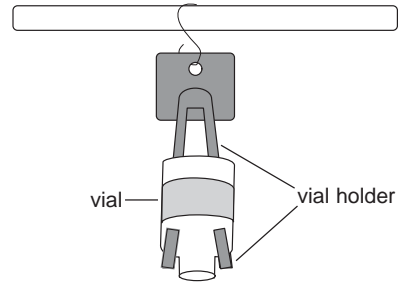

Vial holders allow workers to use both hands to manipulate syringes.

Workers should consider using the following controls:

- Depress plungers slowly when using filters.
- When you need to apply greater force to the plunger, stand and use your shoulder and the palm of your hand, not just your fingers.



Using carts

Workers use carts to hold and transport various items, including ward stock, narcotics, and patient medications.

Potential risk factors

- Pushing and manoeuvring carts may cause awkward shoulder and back postures as well as forceful exertion.
- Loading carts with supplies may cause awkward shoulder and back postures.
- Cart handles may cause contact stress on the palms of the hands.

Potential controls — employers

Employers should consider implementing the following controls, where applicable.

Inspect carts regularly

Conduct regular inspections of carts to ensure that they are in good working order and suitable for the tasks for which they are intended. Inspections may include examining the handles, wheels, and casters for cracks and proper rotation.

Provide larger diameter wheels

Provide larger diameter wheels, which generally make it easier to push carts and can improve the stability of carts on rough ground. Wheels that are too small may get caught in the gaps between elevators and floors. Keep in mind that overall cart height will increase with larger diameter wheels. While this may help elevate low cart shelves, it will also elevate high shelves and working areas.



Maintain wheels and casters

Maintain wheels and casters to ensure proper operation. Maintenance includes cleaning and lubricating wheels and casters regularly. Wheels and casters can get dirty and start to stick, making pushing and steering difficult.

Casters can have two types of bearings:

- Sealed precision ball bearings roll easily and require little maintenance.
- Roller bearings are common but require regular lubricating.

Harder or softer wheels are available:

- Harder materials (for example, nylon) roll easily on hard, smooth surfaces but are more difficult to roll over floor cracks or elevator gaps.
- Softer wheels (for example, rubber or polyurethane) roll more easily on rough surfaces but are harder to push on hard, smooth surfaces.

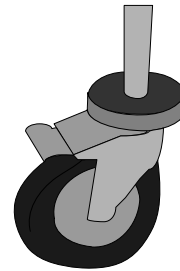

Provide appropriate caster configurations

Carts can be difficult to steer through hallways and around obstacles. Choose the best caster arrangement for your situation.

Busy or small spaces — Use four swivel casters

Swivel casters provide the most steering freedom and are best in busy or small spaces. Carts with four swivel casters, however, are not very good for long distances. They are more difficult to keep moving in a straight line and tend to swerve off in one direction if not held steady.

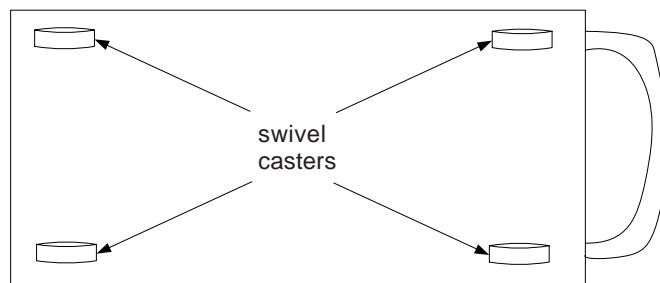



Long-distance pushing and turning 90° — Use two swivel casters at the back and two fixed casters at the front

A configuration of two swivel casters at the back and two fixed casters at the front is best for long distances and frequent 90° turns because workers can push from behind and steer easily. However, these carts are not as easy to steer in busy or small spaces.

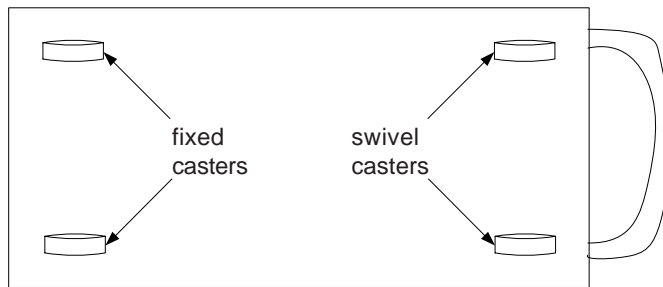

Add handles to carts

Add handles to carts to allow workers to push with their hands between waist and shoulder height. Vertical handles are usually better than horizontal handles. Vertical handles allow workers to adjust the height of their hands and maintain their forearms in a neutral posture. A disadvantage of vertical handles is that they only allow for a fixed shoulder width. No matter which type of handles you use, they should be padded with a rubber-like surface to reduce contact stress and improve gripping ability.

Potential controls — workers

Workers should consider using the following controls.

Select appropriate carts

Select the appropriate cart for each task that you perform. Avoid trying to adapt the task to fit the cart.

Do not overload carts

Overloading carts can increase the pushing force required, hinder manoeuvrability, and increase the risk of tipping or spilling accidents. Load a reasonable amount of material and make a second trip if necessary.



Keep cart heights below your field of vision

Ensure that carts and their loads are low enough to allow a full field of vision when moving the cart. The top of the load should be between waist and shoulder height. Also, avoid storing items above shoulder height or below knee height to prevent excessive reaching and awkward postures.

Use good body mechanics

Follow these guidelines:

- Push carts rather than pulling them.
- Bend your knees.
- Stagger your feet, placing one foot forward and one back.
- Use your legs to push rather than your back.



Education and training **5**

This part provides information on educating and training workers on MSI prevention in your pharmacy. It includes the following sections:

- Sample education module for MSI prevention in hospital pharmacies
- Guidelines for occupational health and safety training





Sample education module for MSI prevention in hospital pharmacies

This sample education module is for pharmacy workers, including pharmacists and pharmacy technicians. It is recommended that the following seven components be covered over a few sessions to allow participants enough time to absorb the information. For more information on effective health and safety training, see “Guidelines for occupational health and safety training,” on page 60.

1. Introduction and goals

- reasons for training
- what participants should know by the end of the course or session
- WCB requirements
- facility-specific MSI prevention policies and procedures

2. What is musculoskeletal injury (MSI)?

- common types of MSI
- signs and symptoms of MSI
- progression of a typical MSI
- health effects of MSI

3. Risk factors for MSI

- general risk factors
- pharmacy-specific risk factors
- identifying risk factors

4. Risk assessment

- assessing work areas, equipment, loads, and tasks



5. Control measures

- hierarchy of control measures (elimination or substitution, engineering or administrative controls, and personal protective equipment)
- general control measures (for example, workspace layout, work organization, and rest breaks)
- pharmacy-specific control measures

6. Body mechanics

- safe posture
- lifting, lowering, and carrying
- pushing and pulling
- stretching and relaxation
- personal factors
- practice sessions

7. Techniques and procedures

- safe syringe manipulation
- safe lifting, lowering, and carrying
- safe pushing and pulling
- suitable computer workstation layout
- suitable working heights
- demonstrations
- practice sessions

Suggested handouts

- MSI prevention program for the facility
- MSI prevention policies and procedures for the facility (for example, safe work procedures)
- stretching exercises



Guidelines for occupational health and safety training

Follow these basic guidelines for effective occupational health and safety training:

1. Assess learning needs.
2. Develop a training program with occupational health and safety specialists and front-line workers. Ensure that the training is:
 - specific to the tasks encountered by the workers
 - specific to the work history of the workers
 - highly interactive and based on adult learning principles
 - tailored to the needs of each audience of workers
3. Provide resources and encourage a high level of worker participation.
4. Train workers, supervisors, and support staff. Ensure that the person delivering the training program is familiar with the occupational risk factors for MSI and the specific tasks required by the job.
5. Supervisors should reinforce safe practices regularly.
6. Re-educate workers, supervisors, and support staff on a regular basis.

Note: OHSAH ergonomists are available for consultation and assistance with setting up a “train the trainer” program in which peers teach peers.



Implementation and evaluation

6

This part provides information on implementing and evaluating an MSI program in your pharmacy. It includes the following sections:

- Pre-implementation evaluation
- Implementation
- Post-implementation evaluation



Pre-implementation evaluation

Evaluating the success of an implementation is important and can be a simple process. Evaluations allow you to see what works and what does not. Conducting an evaluation before implementing control measures helps clarify what you are trying to accomplish and establishes current risk levels. Knowing current risk levels will make it easier for you to evaluate the effectiveness of control measures after implementation.

Step 1. Determine what you are trying to evaluate

What are the areas of concern? What equipment or tasks do workers have difficulty with?

Step 2. Identify potential risk factors for MSI

Does it appear that risk factors are present? Observe the relevant areas of the pharmacy, noting details such as worker body posture, repetitive motion, and workstation layouts.

Step 3. Investigate and assess the current risk of MSI

Use one or more of the following three tools to evaluate the current risk of MSI.

Tool 1: Signs and symptoms survey

A signs and symptoms survey (see Appendix I) helps determine if workers are currently experiencing signs and symptoms of MSI. Make copies and survey workers during the risk identification stage, before controls are implemented. Allowing workers to complete the survey anonymously will likely increase the return rate.



Tool 2: Interviews and focus groups

Interviews allow for open discussion and can provide more information than surveys. Schedule individual meetings with workers or small groups of workers. What do workers feel are priorities in the pharmacy? Let workers know that you are evaluating the worksite, not their performance. Maintaining a level of confidentiality may improve the level of discussion (for example, do not record names with concerns or suggestions).

Tool 3: Incident reports

Analyze incident report forms, going back 1–3 years. How often have incidents occurred in the past? Use this tool in combination with one of the other two tools. Workers may have signs or symptoms of MSI even though few incidents are, or have been, reported.

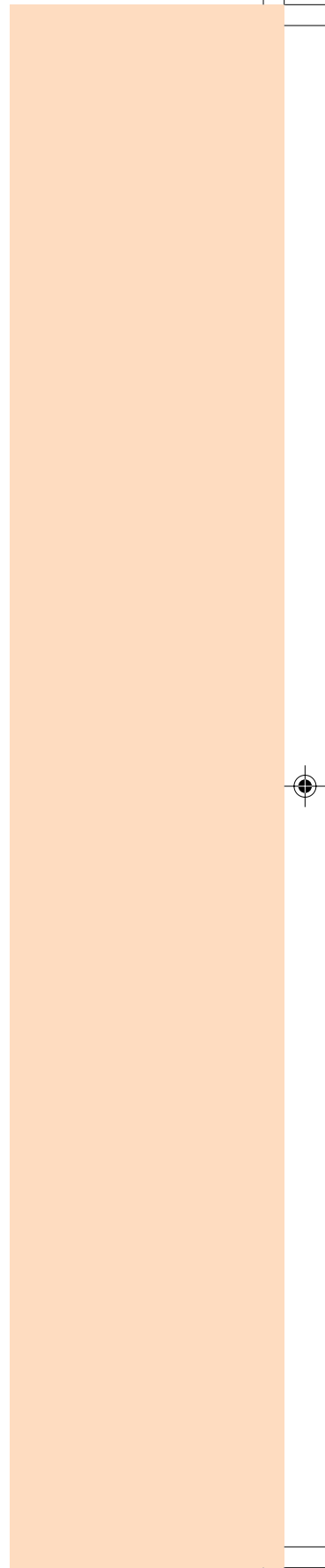



Implementation

After you have identified the potential risk factors and appropriate control measures for your pharmacy, the next step is to implement those control measures. As part of the implementation process, you should create a working group and complete an implementation guideline.

Create a working group

Create a working group to oversee the implementation process. Include the following individuals:

- managers
- pharmacists
- pharmacy technicians
- maintenance workers
- a safety professional (for example, an ergonomist, occupational health and safety consultant, MSI prevention advisor, occupational therapist, physiotherapist, or union safety steward)

Complete an implementation guideline

Discuss possible control measures and come to a consensus about which measures should be implemented. Write down all the control measures that the working group wants to implement (see the implementation guideline in Appendix IV). Include reasons for decisions, target dates for implementation, and names of individuals who will oversee the implementation process.

Once your implementation guideline is finalized, give each working group participant a copy. Post a copy in the pharmacy for easy reference and check off control measures as they are implemented. If a recommendation is not in place by a specific deadline, you can be assured that at least one person will bring attention to it.

OSHTip:

To avoid roadblocks, involve everyone who will be affected by the control measures.



Post-implementation evaluation

Conducting evaluations after implementation helps determine the effectiveness of the implemented control measures. Evaluate control measures at least once a year. Also conduct evaluations whenever workloads or processes change significantly and whenever an injury or other incident occurs.

Step 1. Identify potential risk factors for MSI

Does it appear that the risk factors you intended to address have been eliminated or minimized? Observe the relevant areas of the pharmacy, noting details such as worker body posture, repetitive motion, and workstation layouts.

Step 2. Evaluate if the risk of MSI has decreased

Has the risk of MSI decreased as a result of implemented control measures? Your evaluation should:

- re-evaluate the risk factors that you intended to eliminate or minimize
- determine if the controls have created new risk factors

Use one or more of the following three tools to evaluate whether or not the risk of MSI has decreased.

Tool 1: Signs and symptoms survey

Survey workers three months after the changes have been implemented. Signs and symptoms should decrease with the new control measures as long as the new measures have not created any new risks.

Tool 2: Interviews and focus groups

Schedule individual meetings with workers or small groups of workers. Let workers know that you are evaluating the control measures, not their performance.



OSHTip:

Make MSI reduction a continuous, ongoing process.

Tool 3: Incident reports

Analyze incident report forms, comparing reports from 1–3 years before any controls were implemented with reports from 1–3 years afterwards. Did reported incidents decrease after changes were made? Use this tool in combination with one of the other two tools.

Step 3. Compile the results

Keep your evaluation results for future reference.

Step 4. Understand the results

Determine whether or not the control measures were helpful, *and whether or not the new procedures or new equipment are being used*. If the new control measures were not effective, review the risk factors and develop new solutions. Gather the working group together without delay and try another control measure or modify the control measures currently in place.



Appendices

These appendices provide additional information and resources that will help you improve health and safety in your pharmacy. Appendices include the following:

- Appendix I: Signs and symptoms survey
- Appendix II: Risk factor identification checklist
- Appendix III: WCB ergonomics requirements
- Appendix IV: Implementation guideline
- Appendix V: Stretching routine
- Appendix VI: Recommendations for selecting laminar flow hoods
- Appendix VII: References



Appendix I: Signs and symptoms survey

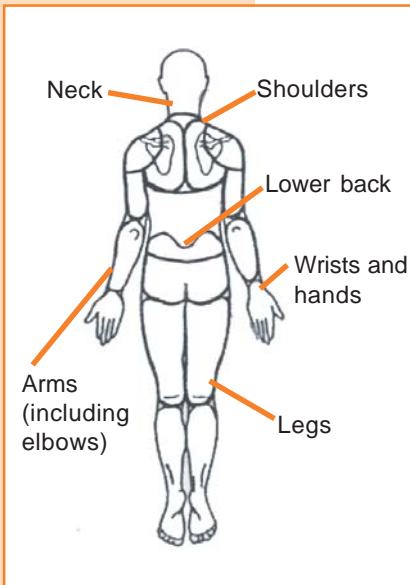

Date: _____

Department: _____

Job or task: _____

Comments: _____

Thinking back over your last week of work, please rate your average level of discomfort while at work for each of the following body parts, using the form on page 69. For each body part, indicate the side of the body that is affected and circle a number on the scale from 0 to 5 to represent your discomfort on that side. The number 0 represents no discomfort, while 5 represents extreme discomfort.





			No discomfort → Extreme discomfort					
1. Neck	___ left	0	1	2	3	4	5	
	___ right	0	1	2	3	4	5	
2. Shoulders	___ left	0	1	2	3	4	5	
	___ right	0	1	2	3	4	5	
3. Lower back	___ left	0	1	2	3	4	5	
	___ right	0	1	2	3	4	5	
4. Arms (incl. elbows)	___ left	0	1	2	3	4	5	
	___ right	0	1	2	3	4	5	
5. Wrists and hands	___ left	0	1	2	3	4	5	
	___ right	0	1	2	3	4	5	
6. Legs	___ left	0	1	2	3	4	5	
	___ right	0	1	2	3	4	5	



Appendix II: Risk factor identification checklist

Use this checklist to identify potential risk factors for MSI in your pharmacy. Before filling out the checklist, familiarize yourself with the tasks performed in the pharmacy. Checking “Yes” for items indicates that potential risk factors may be present. For help determining control measures for the identified risk factors, refer to Parts 3 and 4 of this guide.

Observer: _____

Date: _____

Potential risk factor	Yes	No	N/A
<i>Using dispensary computer workstations</i>			
Do workers perform keying and mouse tasks for more than four hours per shift?			
Do workers perform seated tasks for more than four hours per shift?			
Do workers' feet hang and not touch the ground?			
Are workers unable to pull the keyboard tray close to their bodies?			
Is the monitor out of line with the keyboard?			
Is the top line of text on the monitor above or below eye level?			
Is the mouse on a different surface level than the keyboard?			
Are data entry forms laid flat on the desktop?			
Do workers frequently hold phones between their ears and shoulders?			
Do workers bend excessively at the waist or neck to check orders?			
Do workers reach beyond forearm length to access commonly used supplies?			
Is the lighting inadequate for reading?			
<i>Using dispensary benches</i>			
Do workers reach above shoulder height to reach the top supply shelf or drawer?			
Do workers bend excessively at the waist to reach the bottom supply shelf or drawer?			
Do workers bend excessively at the waist to use the bench?			



Potential risk factor	Yes	No	N/A
Do workers elevate their shoulders or lift their elbows to use the bench?			
Does the bench have limited leg or knee clearance?			
Do workers use excessive force (for example, when crushing pills)?			
Do workers use repetitive fine finger motions?			
Do workers stand for long periods on hard surfaces?			
<i>Prepacking tablets and capsules and making blister pack cards</i>			
Do workers bend their necks to operate the pill packing machine?			
Do workers bend their necks to see under the heat sealer lid?			
Do workers use repetitive fine finger motions to place pills into trays?			
Do workers reach excessively when closing the top of the heat sealer?			
Do workers stand for long periods on hard surfaces?			
<i>Replenishing ward stock</i>			
Do workers reach above shoulder height to reach the top supply shelf or drawer?			
Do workers bend excessively at the waist to reach the bottom supply shelf or drawer?			
Do workers lift and carry ward stock items to the wards?			
Do workers lack an appropriate work surface for organizing ward stock items before delivery?			
Do workers lack access to devices such as carts and dollies?			
Do workers stand for long periods on hard surfaces?			
Do workers push carts? (See "Using carts," on page 73.)			
<i>Shipping, receiving, storing, and ordering</i>			
Do workers reach above shoulder height to reach the top supply shelf or supply boxes?			
Do workers bend excessively at the waist to reach the bottom supply shelf or supply boxes?			
Do workers lift or carry supplies?			
Do the supply boxes offer poor grip or no grip (for example, no handles)?			
Do workers lack access to devices such as carts and dollies?			
Do workers stand for long periods on hard surfaces?			
Do workers push carts? (See "Using carts," on page 73.)			



Potential risk factor	Yes	No	N/A
<i>Non-sterile manufacturing</i>			
Do workers elevate their shoulders or lift their elbows to levigate?			
Do workers use excessive force to levigate?			
Do workers use repetitive arm motions?			
<i>Using glove boxes</i>			
Do workers bend excessively at the waist to use the glove box?			
Do workers reach beyond forearm length to use the glove box?			
Do workers use pinch grips?			
Do workers use the glove box for more than two hours per shift?			
Is the view into the glove box obscured?			
Is the lighting inadequate?			
Is there surface glare from the glove box?			
<i>Compounding and preparing chemotherapy bags</i>			
Do workers reach above shoulder height to reach the overhead bar?			
Do workers bend excessively at the waist to reach the overhead bar?			
Do workers reach beyond forearm length to access commonly used supplies?			
Is there inadequate legroom under the biological safety cabinet?			
Do workers use pinch grips?			
Do workers extend their necks to manipulate IV bags hanging from the overhead bar?			
Do workers use excessive force to seal IV bag tubing?			
Do workers bend their necks down to manipulate supplies?			
Do workers twist to see the order sheet?			
Do workers press their arms against or lean on the edge of the biological safety cabinet or laminar flow hood?			
Do workers use repetitive hand and wrist motions to reconstitute?			
Is the lighting inadequate?			
Is there surface glare from the sash of the biological safety cabinet?			
Is the view into the biological safety cabinet or laminar flow hood obscured by the top of the cabinet or hood?			
Do workers stand for long periods on hard surfaces?			
Do workers fill syringes repetitively? (See "Using syringes," on page 73.)			



Potential risk factor	Yes	No	N/A
<i>Using syringes</i>			
Do workers use only one hand to manipulate syringes?			
Do syringe plungers press into workers' palms?			
Do workers use repetitive hand and wrist motions?			
Do workers use awkward hand and wrist postures to hold medication vials?			
Do workers use excessive force to draw up and inject medications?			
Do workers hold or use syringes improperly?			
<i>Using carts</i>			
Are the carts difficult to push or manoeuvre?			
Are the cart wheels too small or poorly maintained?			
Do the carts have appropriate caster configurations?			
Do the carts lack padded handles?			
Do workers use inappropriate or overloaded carts?			
Do workers bend excessively at the waist to push carts?			
Do workers reach above shoulder height to reach the top shelf or drawer?			
Do workers bend excessively at the waist to reach the bottom shelf, platform, or drawer?			
Do workers push carts over long distances (greater than 60 m [195 ft.]?)			
Do workers push carts over ramps, door frames, or uneven surfaces?			



Appendix III: WCB ergonomics requirements

Under the authority of the *Workers Compensation Act*, the WCB has adopted and implemented ergonomics requirements, detailed in the Occupational Health and Safety Regulation, Sections 4.46 to 4.53 (reprinted in this appendix). These requirements represent the minimum standards that must be complied with at workplaces that fall under WCB jurisdiction and within the scope of the Act.

Ergonomics (MSI) requirements

The purpose of sections 4.46 to 4.53 is to eliminate or, if that is not practicable, minimize the risk of musculoskeletal injury to workers.

Note: The WCB provides publications to assist with implementing the Ergonomics (MSI) Requirements. *Preventing Musculoskeletal Injury (MSI): A Guide for Employers and Joint Committees* provides a seven-step process to assist with the application of the ergonomics requirements along with procedures to investigate incidents of MSI and a table of common control measures. *Understanding the Risks of Musculoskeletal Injury (MSI)* is intended to help employers with the requirements of section 4.51(1) to educate workers in risk identification, signs and symptoms of MSI, and their potential health effects.

4.46 Definition

In sections 4.47 to 4.53 (the Ergonomics (MSI) Requirements)

“*musculoskeletal injury*” or “MSI” means an injury or disorder of the muscles, tendons, ligaments, joints, nerves, blood vessels or related soft tissue including a sprain, strain and inflammation, that may be caused or aggravated by work.

4.47 Risk identification

The employer must identify factors in the workplace that may expose workers to a risk of musculoskeletal injury (MSI).



4.48 Risk assessment

When factors that may expose workers to a risk of MSI have been identified, the employer must ensure that the risk to workers is assessed.



4.49 Risk factors

The following factors must be considered, where applicable, in the identification and assessment of the risk of MSI:

- (a) the physical demands of work activities, including
 - (i) force required,
 - (ii) repetition,
 - (iii) duration,
 - (iv) work postures, and
 - (v) local contact stresses;
- (b) aspects of the layout and condition of the workplace or workstation, including
 - (i) working reaches,
 - (ii) working heights,
 - (iii) seating, and
 - (iv) floor surfaces;
- (c) the characteristics of objects handled, including
 - (i) size and shape,
 - (ii) load condition and weight distribution, and
 - (iii) container, tool and equipment handles;
- (d) the environmental conditions, including cold temperature;
- (e) the following characteristics of the organization of work:
 - (i) work-recovery cycles;
 - (ii) task variability;
 - (iii) work rate.

4.50 Risk control

- (1) The employer must eliminate or, if that is not practicable, minimize the risk of MSI to workers.

- 
- 
- 
- (2) Personal protective equipment may only be used as a substitute for engineering or administrative controls if it is used in circumstances in which those controls are not practicable.
 - (3) The employer must, without delay, implement interim control measures when the introduction of permanent control measures will be delayed.

4.51 Education and training

- (1) The employer must ensure that a worker who may be exposed to a risk of MSI is educated in risk identification related to the work, including the recognition of early signs and symptoms of MSIs and their potential health effects.
- (2) The employer must ensure that a worker to be assigned to work which requires specific measures to control the risk of MSI is trained in the use of those measures, including, where applicable, work procedures, mechanical aids and personal protective equipment.

4.52 Evaluation

- (1) The employer must monitor the effectiveness of the measures taken to comply with the Ergonomics (MSI) Requirements and ensure they are reviewed at least annually.
- (2) When the monitoring required by subsection (1) identifies deficiencies, they must be corrected without undue delay.

4.53 Consultation

- (1) The employer must consult with the joint committee or the worker health and safety representative, as applicable, with respect to the following when they are required by the Ergonomics (MSI) Requirements:
 - (a) risk identification, assessment and control;
 - (b) the content and provision of worker education and training;
 - (c) the evaluation of the compliance measures taken.
- (2) The employer must, when performing a risk assessment, consult with
 - (a) workers with signs or symptoms of MSI, and
 - (b) a representative sample of the workers who are required to carry out the work being assessed.



Appendix IV: Implementation guideline

Date: _____

Working group: _____

Control	Person(s) responsible	In place by (date)	In place on time? (Y/N)	Potential barriers?

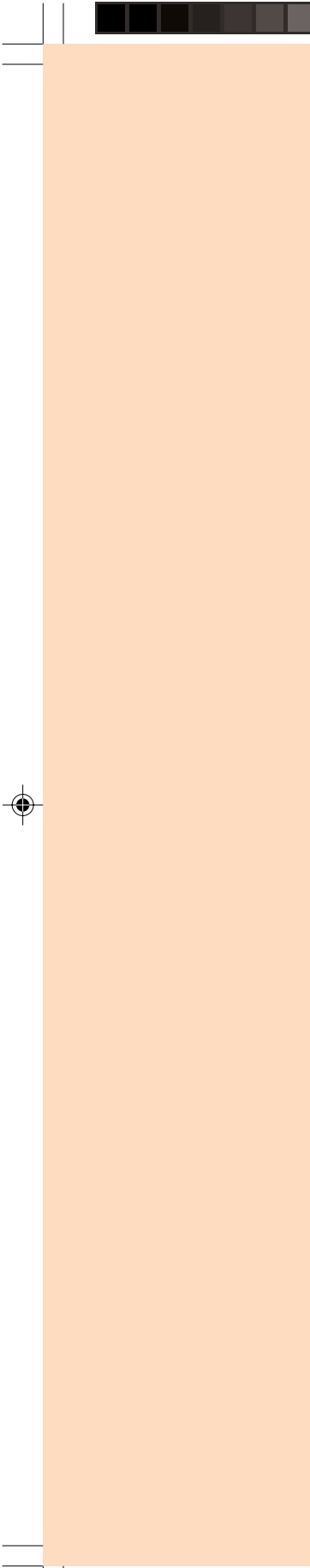

Comments





Appendix V: Stretching routine

STRETCH IT OUT!

Hold each stretch for 15-20 seconds

Regular stretching can help to reduce muscle tension and risk of injury. Perform each stretch slowly and without bouncing. If you feel pain, stop the stretch and consult your physician.

		
Side of Neck	Back of Neck	Chest
		
Shoulder	Triceps	Forearm & Wrist
		
Calf	Front of Thigh	Back of Thigh



OHSAB

Occupational Health and Safety Agency for Healthcare in BC

Making Healthcare a Healthier Place to Work

Suite 301-1185 West Broadway, Vancouver, BC V6H 3X5

Phone: 604 - 775 - 4034 Toll Free: 1 - 800 - 359 - 6612 Fax: 604 - 775 - 4031 Web Site: www.ohsab.bc.ca

Appendix VI: Recommendations for selecting laminar flow hoods

The following list of recommendations is meant to help employers select new laminar flow hoods for use in sterile manufacturing areas. These recommendations take into account human size and shape (anthropometry), activities performed in laminar flow hoods, and ways of minimizing awkward postures that may contribute to the risk of MSI.

Dimensions are based on the norms for American adults aged 19–60. The fifth percentile female represents the smallest typical worker while the ninety-fifth percentile male represents the largest typical worker. This range of body dimensions is often used as a design criterion.

Posture considerations

The laminar flow hood should accommodate comfortable working postures for sitting and standing workers. Ideal body posture while manipulating objects in the hood, whether sitting or standing, includes all of the following angles:

- neck bent 10° or less
- back bent 10° or less
- 45° or less between the body and upper arm
- 120° or less between the upper arm and forearm
- 15° or less between the forearm and wrist

In addition, the legs should be supported and balanced.

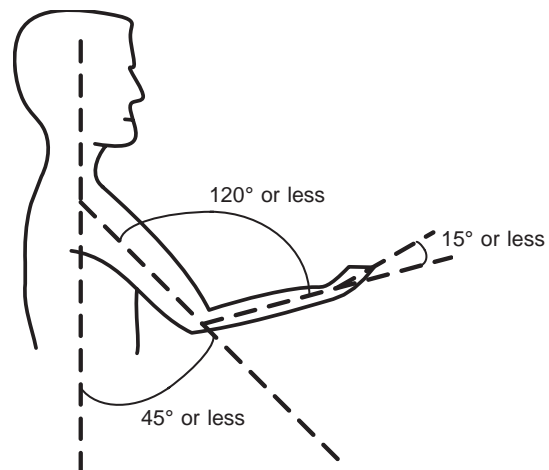

Ideal body posture angles for workers sitting or standing at laminar flow hoods.

Primary functional considerations

The following eight primary functional considerations influence working posture:

1. height of the work surface
2. legroom beneath the work surface
3. height of the hood opening
4. depth of the work surface
5. height of the IV bag support bar
6. support for the feet while sitting
7. contact stress at the front edge of the work surface
8. clear sides for visibility

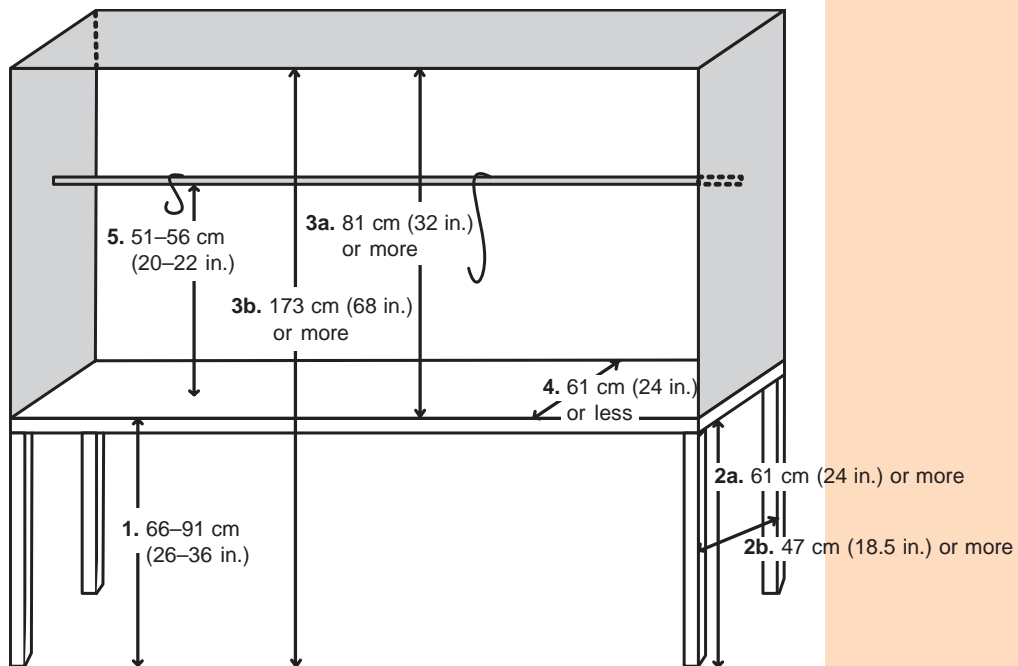

Recommended dimensions for laminar flow hoods.



1. Height of the work surface

If the work surface height is adjustable, it should be 66–91 cm (26–36 in.). This range assumes that the work surface is 5 cm (2 in.) thick and is based on the leg clearance of the tallest sitting worker and the elbow height of shortest worker. The work surface height should accommodate both sitting and standing tasks.

If the height of the work surface is not adjustable, it should be fixed at 91 cm (36 in.) to allow for standing workers. Provide chairs or stools with footrests so workers who choose to sit while working can raise themselves to an appropriate height and maintain leg support.

2. Legroom beneath the work surface

The space beneath the work surface should be at least 61 cm (24 in.) high and 47 cm (18.5 in.) deep. These minimum dimensions for the support structure are based on legroom for the tallest seated worker.

3. Height of the hood opening

The height of the hood opening should be 81 cm (32 in.) or more. The upper edge of the front opening should be at least 173 cm (68 in.) high. This height accommodates the eye level of the tallest standing worker, allowing for a clear view of all areas in the hood.

4. Depth of the work surface

The depth of the work surface in the laminar flow hood should be 61 cm (24 in.) or less to ensure that the smallest worker can maintain a neutral posture. Reach is typically determined by the placement of work within the hood. Workers should place frequently used items closest to themselves, ideally no further than 41 cm (16 in.) from the front edge of the work surface but at least 15 cm (6 in.) in to protect themselves and the materials.

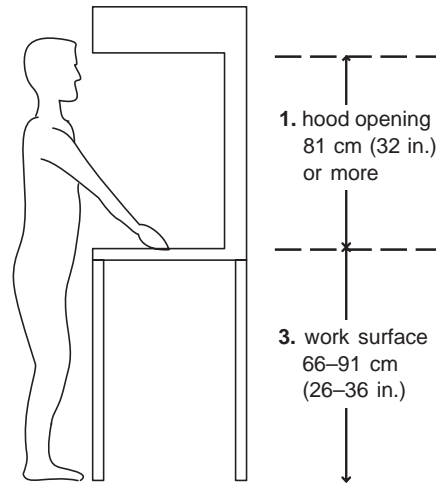

Recommended heights for work surfaces and hood openings in laminar flow hoods.



5. Height of the IV bag support bar

The height of the IV bag support bar should be 51–56 cm (20–22 in.) above the work surface. The height of the bar and the length of the hooks determine the maximum height that workers have to reach to hang IV bags. Consider the following:

- Hooks currently used for hanging bags are 7–10 cm (3–4 in.) long.
- Workers hold bags near the top to hang them.
- Workers should handle IV bags and syringes 12–35 cm (5–14 in.) below the bar, depending on the size of the bags.
- Workers need 7–10 cm (3–4 in.) of space below bags for manipulation.
- Small bags require 25-cm (10-in.) hooks and 3-litre bags require 12-cm (5-in.) hooks so workers do not have to lift them too high.
- Workers should lay bags on the work surface or on an IV bag support rather than hang them from the bar whenever practical.

6. Support for the feet while sitting

Consider providing a movable or adjustable footrest to allow workers to sit at an elevated height while working.

7. Contact stress at the front edge of the work surface

Workers often use the front edge of the work surface to support their forearms. Use a rounded edge without a raised lip or closed-cell foam padding to minimize contact stress on forearms and wrists.

8. Clear sides for visibility

Consider a laminar flow hood with clear sides so that frequently used printed information can be posted on the outside facing in and viewed easily from the opposite side of the flow hood.

Appendix VII: References

- Achusim, L. E., T. W. Weller, S. M. Somani, and P. W. Abramowitz. 1990. Comparison of automated and manual methods of syringe filling. *American Journal of Hospital Pharmacy* 47: 2492–95.
- Canadian Society of Hospital Pharmacists. 1996. *Guidelines for preparation of sterile products in pharmacies*. Ottawa: CSHP.
- Daltroy, L. H., M. D. Iversen, M. G. Larson, R. Lew, E. Wright, J. Ryan, C. Zerwling, A. H. Fossel, and M. H. Liang. 1997. A controlled trial of an educational program to prevent low back injuries. *New England Journal of Medicine* 337 (5): 322–28.
- Darcor Ltd. and Ergoweb Inc. 2001. *The ergonomics of manual material handling: Pushing and pulling tasks*. Toronto: Darcor. <www.darcor.com/whatsnew.htm> (January 6, 2004).
- Dickson, L. B., S. M. Somani, G. Herrmann, and P. W. Abramowitz. 1993. Automated compounder for adding ingredients to parenteral nutrient base solutions. *American Journal of Hospital Pharmacy* 50: 678–82.
- Evanoff, B. A., P. C. Bohr, and L. D. Wolf. 1999. Effects of a participatory ergonomics team among hospital orderlies. *American Journal of Industrial Medicine* 35: 358–65.
- Feldstein, A., B. Valanis, W. Vollmer, N. Stevens, and C. Overton. 1993. The back injury prevention project pilot study: Assessing the effectiveness of Back Attack, an injury prevention program among nurses, aides and orderlies. *Journal of Occupational Medicine* 35: 114–20.
- Hayman, J. N. 1980. Developing an educational safety program for pharmacy employees. *Hospital Pharmacy* 15: 56–60.
- Hide, S., C. M. Haslegrave, W. Morris, and A. Adisesh. 2000. Use of syringes and transfer devices in a pharmacy department. *Proceedings of the XIVth Triennial Congress of the International Ergonomics Association and 44th Annual Meeting of the Human Factors and*



Ergonomics Society, San Diego, July 29–August 4, 2000. Santa Monica: Human Factors and Ergonomics Society (CD-ROM). 6-228–31.

Joyce, M. 1999. The role of ergonomics training in industry. In *Occupational Ergonomics Handbook*, edited by W. Karwowski, and W. S. Marras, pp. 1631–40. Boca Raton, Fla.: CRC Press.

Komaki, J., K. D. Barwick, and L. R. Scott. 1978. A behavioural approach to occupational safety: Pinpointing and reinforcing safe performance in a food manufacturing plant. *Journal of Applied Psychology* 63 (4): 434–45.

Kroemer, K. H. E., and E. Grandjean. 1997. *Fitting the task to the human: A textbook of occupational ergonomics*. 5th ed. London: Taylor & Francis.

Linton, S. J. 1991. A behavioral workshop for training immediate supervisors: The key to neck and back injuries? *Perceptual and Motor Skills* 73: 1159–70.

National Institute of Environmental Health Sciences. 2001. NIEHS health and safety guide to laboratory ergonomics. <www.niehs.nih.gov/odhsb/ergoguid/> (January 6, 2004).

Pheasant, S. 1987. Some anthropometric aspects of workstation design. *International Journal of Nursing Studies* 24 (4): 291–98.

Pheasant, S. 1991. *Ergonomics, work and health*. London: Macmillan.

Pheasant, S. 1996. *Bodyspace: Anthropometry, ergonomics and the design of work*. 2nd ed. London: Taylor & Francis.

Putz-Anderson, V., ed. 1988. *Cumulative trauma disorders: A manual for musculoskeletal diseases of the upper limbs*. New York: Taylor & Francis.

Roughton, J. 1993. Integrating quality into safety and health management. *Industrial Engineering* 7: 35–40.

Ryden, L. A., C.A. Molgaard, and S. L. Bobbitt. 1988. Benefits of a back care and light duty health promotion program in a hospital setting. *Journal of Community Health* 13 (4): 222–30.



St. Vincent, M., C. Tellier, and M. Lortie. 1989. Training in handling: An evaluative study. *Ergonomics* 32 (2): 191–210.

University of Minnesota Environmental Health and Safety. Laboratory ergonomics. <www.dehs.umn.edu/ergo/lab/> (January 6, 2004).

Vredenburg, A. G. 2002. Organizational safety: Which management practices are most effective in reducing employee injury rates? *Journal of Safety Research* 33 (2): 259–76.

